



Kinematical correlations: from RHIC to LHC

Antoni Szczurek

INSTITUTE OF NUCLEAR PHYSICS

POLISH ACADEMY OF SCIENCES

IFJ PAN

AND

UNIVERSITY OF RZESZOW



Our recent works on correlations

- Jet-jet correlations (with A. Rybarska and G. Ślipek)
- Photon-jet correlations (with T. Pietrycki)
- Charm-anticharm correlations (with M. Łuszczak)
- Correlations of leptons from semileptonic decays of heavy mesons
- Drell-Yan pair production (with G. Ślipek)
- $J/\psi - gluon$ correlations (with S. Baranov)



Plan of the first part

- Introduction/Motivation
- Theoretical approach(es)
- Matrix elements
- Unintegrated gluon distributions
- Results
- Conclusions

based on:

A. Szczurek, A. Rybarska and G. Slipek,
Phys. Rev. **D76** (2007) 034001.



Introduction/Motivation

Experimental motivation:

New RHIC data for hadron-hadron correlations – indication of **jet structure down to small transverse momenta**

(→ **Jan Rak**)

New PHENIX data

Theoretical motivation:

Dynamics of gluon/parton ladders – a theoretical challenge.

The QCD dynamics (collinear, k_t -factorization) is usually investigated for **inclusive** reactions:

- γ^* -**proton** total cross section (or F_2)
- Inclusive production of **jets**
- Inclusive production of **mesons (pions)**
- Inclusive production of open **charm, bottom, top**
- Inclusive production of **direct photons**
- Inclusive production of **quarkonia**



Introduction/Motivation

Very interesting are:

- Dijet correlations (Leonidov-Ostrovsky, Bartels et al.)
- $Q\bar{Q}$ correlations (\rightarrow Marta Luszczak)
- γ^* – jet correlations (\rightarrow Tomasz Pietrycki)
- jet – J/ψ correlations (Baranov-Szczurek)
- Exclusive reactions: $pp \rightarrow pXp$ where
 $X = J/\psi, \chi_c, \chi_b, \eta', \eta_c, \eta_b$
(Matrin-Khoze-Ryskin, Szczurek-Pasechnik-Teryaev)

They contain much more information about QCD ladders.



QCD motivation

HERA $\gamma^* p$ total cross section ($F_2(x, Q^2)$)

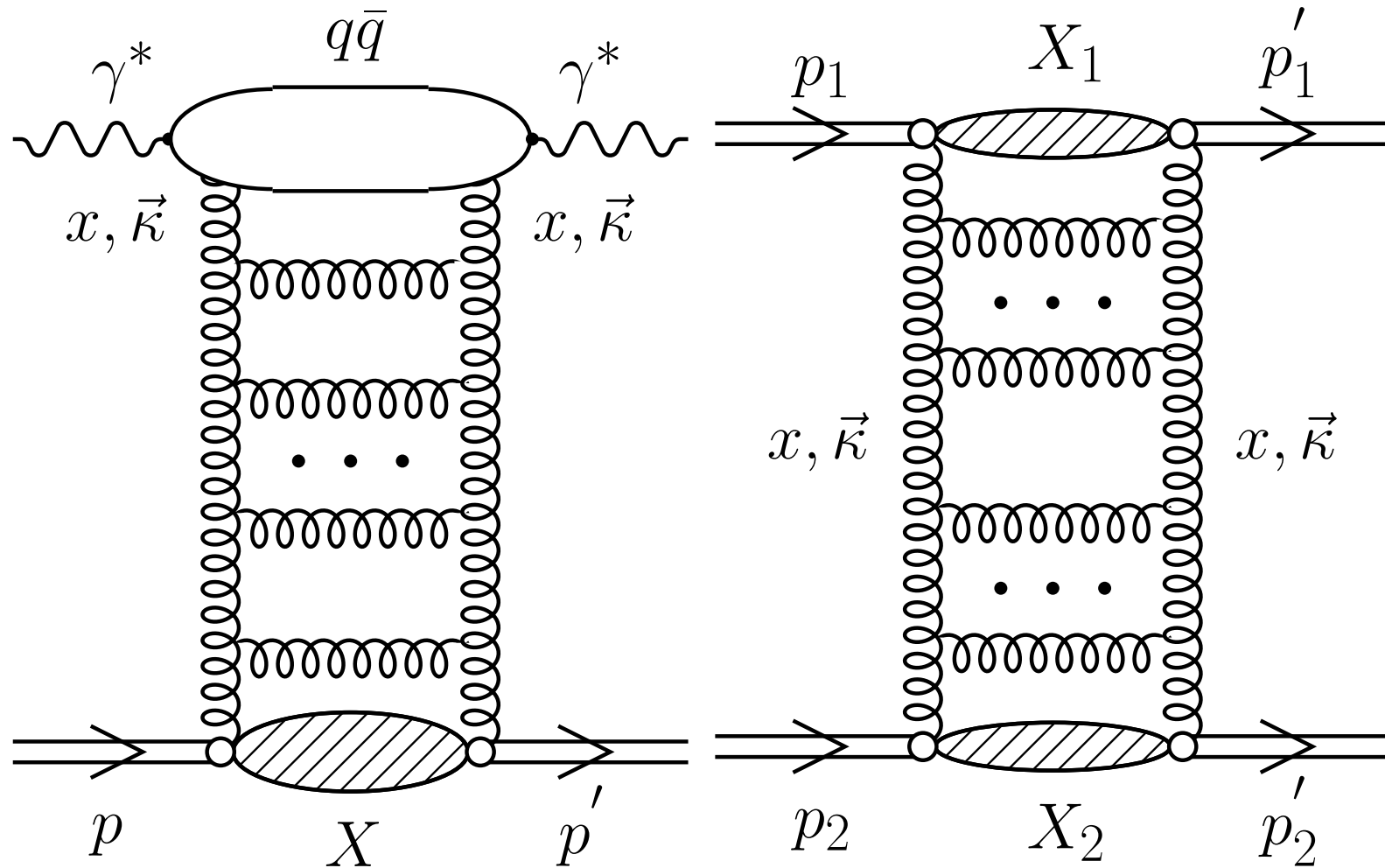



Collinear approach to dijet correlations

In LO:

$$\frac{d\sigma}{d\phi} = f(W) \delta(\phi - \pi) \quad (1)$$

In NLO:

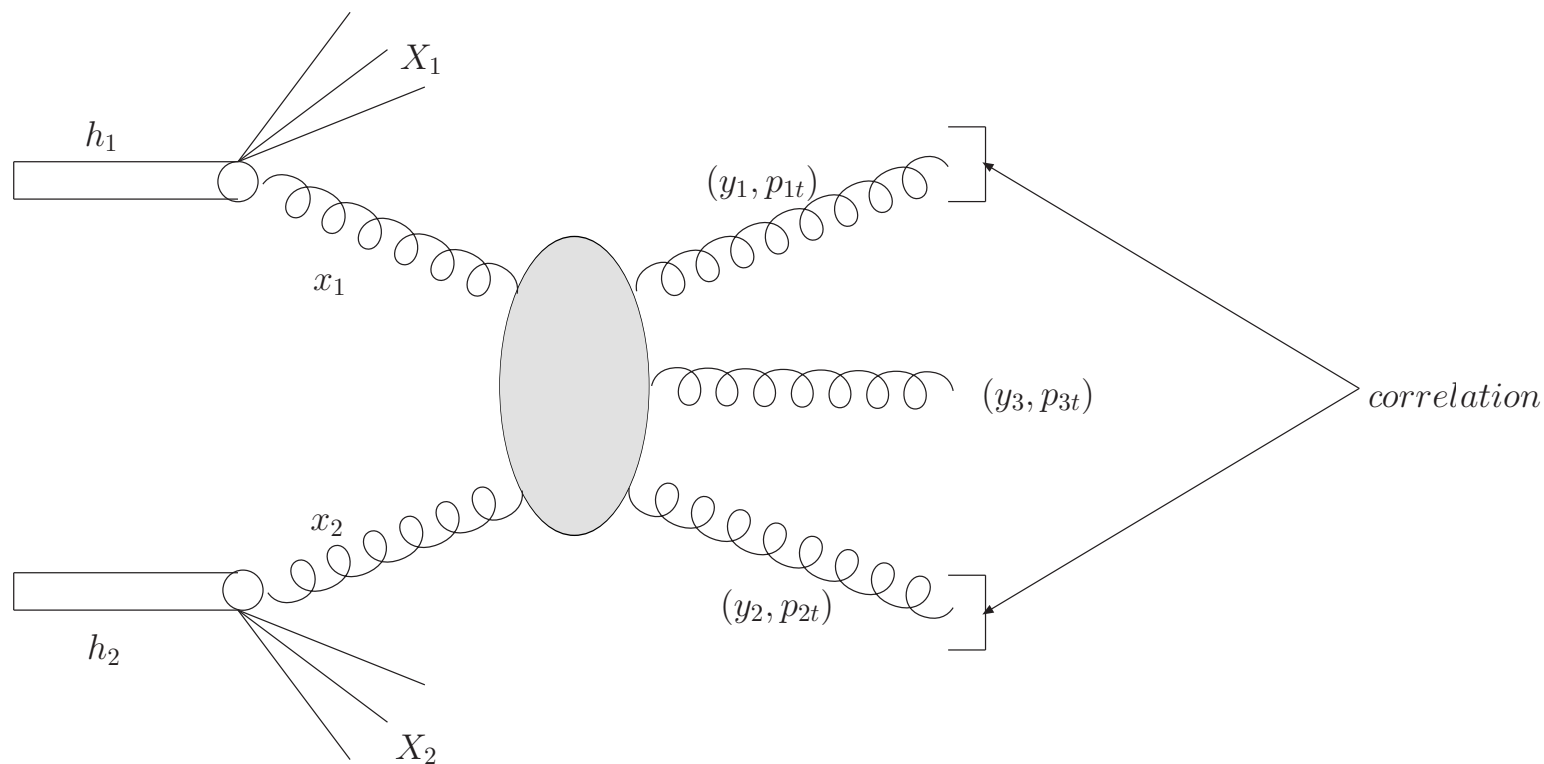

Figure 1: A typical diagram for $2 \rightarrow 3$ contributions.



k_t -factorization approach to dijet correlations

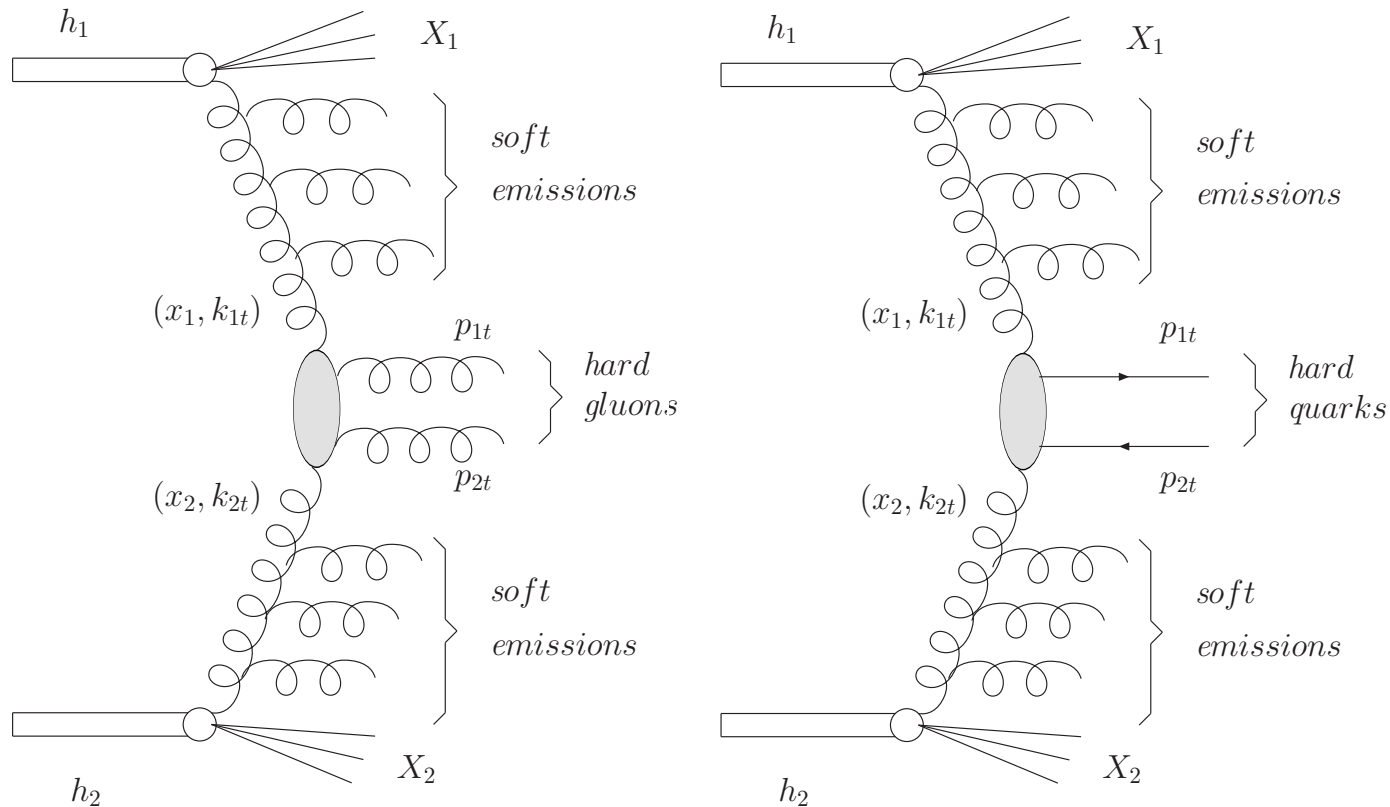

Figure 2: Typical diagrams for k_t -factorization approach.



Pair of partons in k_t -factorization approach

$$\frac{d\sigma(h_1 h_2 \rightarrow jj)}{d^2 p_{1,t} d^2 p_{2,t}} = \int dy_1 dy_2 \frac{d^2 \kappa_{1t}}{\pi} \frac{d^2 \kappa_{2t}}{\pi} \frac{1}{16\pi^2 (x_1 x_2 s)^2} \overline{|\mathcal{M}(gg \rightarrow jj)|^2} \cdot \delta^2(\vec{\kappa}_{1,t} + \vec{\kappa}_{2,t} - \vec{p}_{1,t} - \vec{p}_{2,t}) f(x_1, \kappa_{1,t}^2) f(x_2, \kappa_{2,t}^2)$$

where

$$x_1 = \frac{m_{1t}}{\sqrt{s}} e^{+y_1} + \frac{m_{2t}}{\sqrt{s}} e^{+y_2}, \quad (3)$$

$$x_2 = \frac{m_{1t}}{\sqrt{s}} e^{-y_1} + \frac{m_{2t}}{\sqrt{s}} e^{-y_2}. \quad (4)$$

The final partonic state is $jj = gg, q\bar{q}$.

There are other (quark/antiquark initiated) processes
(\rightarrow [see soon](#))



Pair of partons in k_t -factorization approach

$$f_1(x_1, \kappa_{1,t}^2) \rightarrow x_1 g_1(x_1) \delta(\kappa_{1,t}^2) \quad (5)$$

and

$$f_2(x_2, \kappa_{2,t}^2) \rightarrow x_2 g_2(x_2) \delta(\kappa_{2,t}^2) \quad (6)$$

then one recovers the standard collinear formula.

Inclusive cross sections:

$$\frac{d\sigma(h_1 h_2 \rightarrow j)}{dy_1 d^2 p_{1,t}} = 2 \int dy_2 \frac{d^2 \kappa_{1,t}}{\pi} \frac{d^2 \kappa_{2,t}}{\pi} (\dots) \Big|_{\vec{p}_{2,t} = \vec{\kappa}_{1,t} + \vec{\kappa}_{2,t} - \vec{p}_{1,t}} \quad (7)$$

or equivalently

$$\frac{d\sigma(h_1 h_2 \rightarrow j)}{dy_2 d^2 p_{2,t}} = 2 \int dy_1 \frac{d^2 \kappa_{1,t}}{\pi} \frac{d^2 \kappa_{2,t}}{\pi} (\dots) \Big|_{\vec{p}_{1,t} = \vec{\kappa}_{1,t} + \vec{\kappa}_{2,t} - \vec{p}_{2,t}} \cdot \quad (8)$$



Pair of partons in k_t -factorization approach

The integration with the Dirac delta function in (2)

$$\int dy_1 dy_2 \frac{d^2 \kappa_{1t}}{\pi} \frac{d^2 \kappa_{2t}}{\pi} (\dots) \delta^2(\dots) . \quad (9)$$

can be performed by introducing the following new auxiliary variables:

$$\begin{aligned} \vec{Q}_t &= \vec{\kappa}_{1t} + \vec{\kappa}_{2t} , \\ \vec{q}_t &= \vec{\kappa}_{1t} - \vec{\kappa}_{2t} . \end{aligned} \quad (10)$$

The jacobian of this transformation is:

$$\frac{\partial(\vec{Q}_t, \vec{q}_t)}{\partial(\vec{\kappa}_{1t}, \vec{\kappa}_{2t})} = \begin{pmatrix} 1 & 1 \\ 1 & -1 \end{pmatrix} \cdot \begin{pmatrix} 1 & 1 \\ 1 & -1 \end{pmatrix} = 2 \cdot 2 = 4 . \quad (11)$$



Pair of partons in k_t -factorization approach

Then:

$$\frac{d\sigma(h_1 h_2 \rightarrow Q \bar{Q})}{d^2 p_{1,t} d^2 p_{2,t}} = \frac{1}{4} \int dy_1 dy_2 d^2 Q_t d^2 q_t (\dots) \delta^2(\vec{Q}_t - \vec{p}_{1,t} - \vec{p}_{2,t}) \quad (12)$$

$$= \frac{1}{4} \int dy_1 dy_2 \underbrace{d^2 q_t}_{\dots} (\dots) |_{\vec{Q}_t = \vec{P}_t} = \quad (13)$$

$$= \frac{1}{4} \int dy_1 dy_2 \underbrace{q_t dq_t}_{\dots} d\varphi (\dots) |_{\vec{Q}_t = \vec{P}_t} = \quad (14)$$

$$= \frac{1}{4} \int dy_1 dy_2 \underbrace{\frac{1}{2} dq_t^2}_{\dots} d\varphi (\dots) |_{\vec{Q}_t = \vec{P}_t} . \quad (15)$$

Above $\vec{P}_t = \vec{p}_{1,t} + \vec{p}_{2,t}$.



Pair of partons in k_t -factorization approach

If one is interested in the distribution of the sum of transverse momenta of the outgoing quarks, then it is convenient to write

$$\begin{aligned} d^2 p_{1,t} d^2 p_{2,t} &= \frac{1}{4} d^2 P_t d^2 p_t = \frac{1}{4} d\varphi_+ P_t dP_t d\varphi_- p_t dp_t \\ &= \frac{1}{4} 2\pi P_t dP_t d\varphi_- p_t dp_t . \end{aligned} \quad (16)$$

If one is interested in studying a two-dimensional map $p_{1,t} \times p_{2,t}$ then

$$d^2 p_{1,t} d^2 p_{2,t} = d\phi_1 p_{1,t} dp_{1,t} d\phi_2 p_{2,t} dp_{2,t} . \quad (17)$$

Then

$$\frac{d\sigma(p_{1,t}, p_{2,t})}{dp_{1,t} dp_{2,t}} = \int d\phi_1 d\phi_2 p_{1,t} p_{2,t} \int dy_1 dy_2 \frac{1}{4} q_t dq_t d\phi_{q_t} (\dots) .$$

(18)



Pair of partons in k_t -factorization approach

It is convenient to make the following transformation of variables

$$(\phi_1, \phi_2) \rightarrow (\phi_{sum} = \phi_1 + \phi_2, \phi_{dif} = \phi_1 - \phi_2) , \quad (19)$$

where $\phi_{sum} \in (0, 4\pi)$ and $\phi_{dif} \in (-2\pi, 2\pi)$. Now the new domain (ϕ_{sum}, ϕ_{dif}) is twice bigger than the original one (ϕ_1, ϕ_2) .

$$d\phi_1 d\phi_2 = \left(\frac{\partial\phi_1 \partial\phi_2}{\partial\phi_{sum} \partial\phi_{dif}} \right) d\phi_{sum} d\phi_{dif} . \quad (20)$$

The transformation jacobian is:

$$\left(\frac{\partial\phi_1 \partial\phi_2}{\partial\phi_{sum} \partial\phi_{dif}} \right) = \frac{1}{2} . \quad (21)$$



Pair of partons in k_t -factorization approach

$$\begin{aligned} d^2 p_{1,t} d^2 p_{2,t} &= p_{1,t} dp_{1,t} p_{2,t} dp_{2,t} \frac{d\phi_{sum} d\phi_{dif}}{2} \\ &= p_{1,t} dp_{1,t} p_{2,t} dp_{2,t} 2\pi d\phi_{dif} . \end{aligned} \quad (22)$$

The integrals in Eq.(18) can be written equivalently as

$$\frac{d\sigma(p_{1,t}, p_{2,t})}{dp_{1,t} dp_{2,t}} = \frac{1}{2} \cdot \frac{1}{2} \int d\phi_{sum} d\phi_{dif} p_{1,t} p_{2,t} \int dy_1 dy_2 \frac{1}{4} q_t dq_t d\phi_{q_t} (\dots) . \quad (23)$$

First $\frac{1}{2}$ – jacobian, second $\frac{1}{2}$ – extra extension of the domain.

By symmetry, there is no dependence on ϕ_{sum}

$$\frac{d\sigma(p_{1,t}, p_{2,t})}{dp_{1,t} dp_{2,t}} = \frac{1}{2} \cdot \frac{1}{2} \cdot 4\pi \int d\phi_{dif} p_{1,t} p_{2,t} \int dy_1 dy_2 \frac{1}{4} q_t dq_t d\phi_{q_t} (\dots) . \quad (24)$$



Matrix elements for $2 \rightarrow 2$ processes

The matrix elements for on-shell initial gluons/partons

$$\begin{aligned} \overline{|\mathcal{M}_{gg \rightarrow gg}|^2} &= \frac{9}{2} g_s^4 \left(3 - \frac{\hat{t}\hat{u}}{\hat{s}^2} - \frac{\hat{s}\hat{u}}{\hat{t}^2} - \frac{\hat{s}\hat{t}}{\hat{u}^2} \right), \\ \overline{|\mathcal{M}_{gg \rightarrow q\bar{q}}|^2} &= \frac{1}{8} g_s^4 \left(6 \frac{\hat{t}\hat{u}}{\hat{s}^2} + \frac{4}{3} \frac{\hat{u}}{\hat{t}} + \frac{4}{3} \frac{\hat{t}}{\hat{u}} + 3 \frac{\hat{t}}{\hat{s}} + 3 \frac{\hat{u}}{\hat{s}} \right), \\ \overline{|\mathcal{M}_{gq \rightarrow gq}|^2} &= g_s^4 \left(-\frac{4}{9} \frac{\hat{s}^2 + \hat{u}^2}{\hat{s}\hat{u}} + \frac{\hat{u}^2 + \hat{s}^2}{\hat{t}^2} \right), \\ \overline{|\mathcal{M}_{qg \rightarrow qg}|^2} &= g_s^4 \left(-\frac{4}{9} \frac{\hat{s}^2 + \hat{t}^2}{\hat{s}\hat{t}} + \frac{\hat{t}^2 + \hat{s}^2}{\hat{u}^2} \right). \end{aligned} \quad (25)$$

The matrix elements for off-shell initial gluons – the same formulae but with $\hat{s}, \hat{t}, \hat{u}$ from [off-shell kinematics](#). In this case $\hat{s} + \hat{t} + \hat{u} = k_1^2 + k_2^2$, where $k_1^2, k_2^2 < 0$. Our prescription – a smooth [analytic continuation](#) of the on-shell formula off mass shell.



2 \rightarrow 3 processes in collinear approach

Standard parton model formula:

$$d\sigma(h_1 h_2 \rightarrow ggg) = \int dx_1 dx_2 g_1(x_1, \mu^2) g_2(x_2, \mu^2) d\hat{\sigma}(gg \rightarrow ggg) \quad (26)$$

The elementary cross section can be written as

$$d\hat{\sigma}(gg \rightarrow ggg) = \frac{1}{2\hat{s}} |\overline{\mathcal{M}}_{gg \rightarrow ggg}|^2 dR_3 . \quad (27)$$

The three-body phase space element is:

$$dR_3 = \frac{d^3 p_1}{2E_1 (2\pi)^3} \frac{d^3 p_2}{2E_2 (2\pi)^3} \frac{d^3 p_3}{2E_3 (2\pi)^3} (2\pi)^4 \delta^4(p_a + p_b - p_1 - p_2 - p_3) , \quad (28)$$



2 → 3 processes in collinear-factorization approach

It can be written in an equivalent way as:

$$dR_3 = \frac{dy_1 d^2 p_{1t}}{(4\pi)(2\pi)^2} \frac{dy_2 d^2 p_{2t}}{(4\pi)(2\pi)^2} \frac{dy_3 d^2 p_{3t}}{(4\pi)(2\pi)^2} (2\pi)^4 \delta^4(p_a + p_b - p_1 - p_2 - p_3) , \quad (29)$$

The last formula is useful for practical purposes. Now

$$d\sigma = dy_1 d^2 p_{1t} dy_2 d^2 p_{2t} dy_3 \cdot \frac{1}{(4\pi)^3 (2\pi)^2} \frac{1}{\hat{s}^2} x_1 f_1(x_1, \mu_f^2) x_2 f_2(x_2, \mu_f^2) |\overline{\mathcal{M}}_{2-}|^2 \quad (30)$$

where

$$\begin{aligned} x_1 &= \frac{p_{1t}}{\sqrt{s}} \exp(+y_1) + \frac{p_{2t}}{\sqrt{s}} \exp(+y_2) + \frac{p_{3t}}{\sqrt{s}} \exp(+y_3) , \\ x_2 &= \frac{p_{1t}}{\sqrt{s}} \exp(-y_1) + \frac{p_{2t}}{\sqrt{s}} \exp(-y_2) + \frac{p_{3t}}{\sqrt{s}} \exp(-y_3) . \end{aligned} \quad (31)$$



2 \rightarrow 3 processes in collinear-factorization approach

Repeating similar steps as for 2 \rightarrow 2:

$$d\sigma = \frac{1}{64\pi^4 \hat{s}^2} x_1 f_1(x_1, \mu_f^2) x_2 f_2(x_2, \mu_f^2) \overline{|\mathcal{M}_{2 \rightarrow 3}|^2} p_{1t} dp_{1t} p_{2t} dp_{2t} d\Phi_- dy_1 dy_2 dy_3, \quad (32)$$

where Φ_- is restricted to the interval $(0, \pi)$.



Matrix elements for $2 \rightarrow 3$ processes

For the $gg \rightarrow ggg$ process ($k_1 + k_2 \rightarrow k_3 + k_4 + k_5$) the squared matrix element is

$$\begin{aligned} \overline{|\mathcal{M}|^2} &= \frac{1}{2} g_s^6 \frac{N_c^3}{N_c^2 - 1} \\ & \left[(12345) + (12354) + (12435) + (12453) + (12534) + (12543) + \right. \\ & \quad \left. (13245) + (13254) + (13425) + (13524) + (14325) + (14325) \right] \\ & \times \sum_{i < j} (k_i k_j) / \prod_{i < j} (k_i k_j), \end{aligned} \tag{33}$$

where $(ijklmn) \equiv (k_i k_j)(k_j k_l)(k_l k_m)(k_m k_n)(k_n k_i)$.



Matrix elements for $2 \rightarrow 3$ processes

It is useful to calculate matrix element for the process $q\bar{q} \rightarrow ggg$. The squared matrix elements for other processes can be obtained by crossing the squared matrix element for the process $q\bar{q} \rightarrow ggg$ ($p_a + p_b \rightarrow k_1 + k_2 + k_3$)

$$\begin{aligned} |\overline{\mathcal{M}}|^2 &= g_s^6 \frac{N_c^2 - 1}{4N_c^4} \\ &\sum_i^3 a_i b_i (a_i^2 + b_i^2) / (a_1 a_2 a_3 b_1 b_2 b_3) \\ &\times \left[\frac{\hat{s}}{2} + N_c^2 \left(\frac{\hat{s}}{2} - \frac{a_1 b_2 + a_2 b_1}{(k_1 k_2)} - \frac{a_2 b_3 + a_3 b_2}{(k_2 k_3)} - \frac{a_3 b_1 + a_1 b_3}{(k_3 k_1)} \right) \right. \\ &\left. + \frac{2N^4}{\hat{s}} \left(\frac{a_3 b_3 (a_1 b_2 + a_2 b_1)}{(k_2 k_3)(k_3 k_1)} + \frac{a_1 b_1 (a_2 b_3 + a_3 b_2)}{(k_3 k_1)(k_1 k_2)} + \frac{a_2 b_2 (a_3 b_1 + a_1 b_3)}{(k_1 k_2)(k_2 k_3)} \right) \right] \end{aligned} \quad (34)$$



Matrix elements for $2 \rightarrow 3$ processes

The matrix element for the process $gg \rightarrow q\bar{q}g$ is obtained from that of $q\bar{q} \rightarrow ggg$ by appropriate **crossing**:

$$\overline{|\mathcal{M}|^2}_{gg \rightarrow q\bar{q}g}(k_1, k_2, k_3, k_4, k_5) = \frac{9}{64} \cdot \overline{|\mathcal{M}|^2}_{q\bar{q} \rightarrow ggg}(-k_4, -k_3, -k_1, -k_2, k_5). \quad (36)$$

We sum over 3 final flavours ($f = u, d, s$).

For the $qg \rightarrow qgg$ process

$$\overline{|\mathcal{M}|^2}_{qg \rightarrow qgg}(k_1, k_2, k_3, k_4, k_5) = \left(-\frac{3}{8}\right) \cdot \overline{|\mathcal{M}|^2}_{q\bar{q} \rightarrow ggg}(k_1, -k_3, -k_2, k_4, k_5) \quad (37)$$

and finally for the process $g\bar{q} \rightarrow \bar{q}gg$

$$\overline{|\mathcal{M}|^2}_{g\bar{q} \rightarrow \bar{q}gg}(k_1, k_2, k_3, k_4, k_5) = \left(-\frac{3}{8}\right) \cdot \overline{|\mathcal{M}|^2}_{q\bar{q} \rightarrow ggg}(-k_3, k_2, -k_1, k_4, k_5). \quad (38)$$



Unintegrated gluon distributions (part 1)

Gaussian smearing

$$\mathcal{F}_{naive}(x, \kappa^2, \mu_F^2) = x g^{coll}(x, \mu_F^2) \cdot f_{Gauss}(\kappa^2), \quad (39)$$

$$f_{Gauss}(\kappa^2) = \frac{1}{2\pi\sigma_0^2} \exp(-\kappa_t^2/2\sigma_0^2) / \pi. \quad (40)$$

BFKL UGDF

$$-x \frac{\partial f(x, q_t^2)}{\partial x} = \frac{\alpha_s N_c}{\pi} q_t^2 \int_0^\infty \frac{dq_{1t}^2}{q_{1t}^2} \left[\frac{f(x, q_{1t}^2) - f(x, q_t^2)}{|q_t^2 - q_{1t}^2|} + \frac{f(x, q_t^2)}{\sqrt{q_t^4 + 4q_{1t}^4}} \right] \quad (41)$$



Unintegrated gluon distributions (part 2)

Golec-Biernat-Wuesthoff saturation model
from dipole-nucleon cross section to UGDF

$$\alpha_s \mathcal{F}(x, \kappa_t^2) = \frac{3\sigma_0}{4\pi^2} R_0^2(x) \kappa_t^2 \exp(-R_0^2(x) \kappa_t^2) , \quad (42)$$

$$R_0(x) = \left(\frac{x}{x_0} \right)^{\lambda/2} \frac{1}{\text{GeV}} . \quad (43)$$

Parameters adjusted to **HERA** data for F_2 .

Kharzeev-Levin gluon saturation

$$\mathcal{F}(x, \kappa^2) = \begin{cases} f_0 & \text{if } \kappa^2 < Q_s^2, \\ f_0 \cdot \frac{Q_s^2}{\kappa^2} & \text{if } \kappa^2 > Q_s^2. \end{cases} \quad (44)$$

f_0 adjusted by Szczurek to HERA data for F_2 .



Kwiecinski parton distributions

QCD-most-consistent approach – CCFM.

For LO ($2 \rightarrow 1$) processes convenient to use UPDFs in a space conjugated to transverse momentum (Kwieciński et al.)

$$\tilde{f}(x, b, \mu^2) = \frac{1}{2\pi} \int d^2\kappa \exp(-i\vec{\kappa} \cdot \vec{b}) \mathcal{F}(x, \kappa^2, \mu^2)$$

$$\mathcal{F}(x, \kappa^2, \mu^2) = \frac{1}{2\pi} \int d^2b \exp(i\vec{\kappa} \cdot \vec{b}) \tilde{f}(x, b, \mu^2)$$

The relation between

Kwieciński UPDF and the collinear PDF:

$$xp_k(x, \mu^2) = \int_0^\infty d\kappa_t^2 f_k(x, \kappa_t^2, \mu^2)$$



Kwiecinski parton distributions

At $b = 0$ the functions f_j are related to the familiar integrated parton distributions, $p_j(x, Q)$, as follows:

$$f_j(x, 0, Q) = \frac{x}{2} p_j(x, Q).$$

$$p_{NS} = u - \bar{u}, \quad d - \bar{d},$$

$$p_S = \bar{u} + u + \bar{d} + d + \bar{s} + s + \dots,$$

$$p_{\text{sea}} = 2\bar{d} + 2u + \bar{s} + s + \dots,$$

$$p_G = g,$$

where ... stand for higher flavors.



Kwiecinski equations

for a given impact parameter:

$$\frac{\partial f_{NS}(x, b, Q)}{\partial Q^2} = \frac{\alpha_s(Q^2)}{2\pi Q^2} \int_0^1 dz P_{qq}(z) \left[\Theta(z-x) J_0((1-z)Qb) f_{NS}\left(\frac{x}{z}, b, Q\right) - f_{NS}(x, b, Q) \right]$$

$$\frac{\partial f_S(x, b, Q)}{\partial Q^2} = \frac{\alpha_s(Q^2)}{2\pi Q^2} \int_0^1 dz \left\{ \Theta(z-x) J_0((1-z)Qb) \left[P_{qq}(z) f_S\left(\frac{x}{z}, b, Q\right) + P_{qg}(z) f_G\left(\frac{x}{z}, b, Q\right) \right] - [zP_{qq}(z) + zP_{gq}(z)] f_S(x, b, Q) \right\}$$

$$\frac{\partial f_G(x, b, Q)}{\partial Q^2} = \frac{\alpha_s(Q^2)}{2\pi Q^2} \int_0^1 dz \left\{ \Theta(z-x) J_0((1-z)Qb) \left[P_{gq}(z) f_S\left(\frac{x}{z}, b, Q\right) + P_{gg}(z) f_G\left(\frac{x}{z}, b, Q\right) \right] - [zP_{gg}(z) + zP_{qg}(z)] f_G(x, b, Q) \right\}$$



Nonperturbative effects

Transverse momenta of partons due to:

- perturbative effects
(solution of the Kwieciński- CCFM equations),
- nonperturbative effects
(intrinsic momentum distribution of partons)

Take factorized form in the b-space:

$$\tilde{f}_q(x, b, \mu^2) = \tilde{f}_q^{CCFM}(x, b, \mu^2) \cdot F_q^{np}(b) .$$

We use a flavour and x independent form factor

$$F_q^{np}(b) = F^{np}(b) = \exp\left(\frac{-b^2}{4b_0^2}\right)$$

May be too simplistic ?

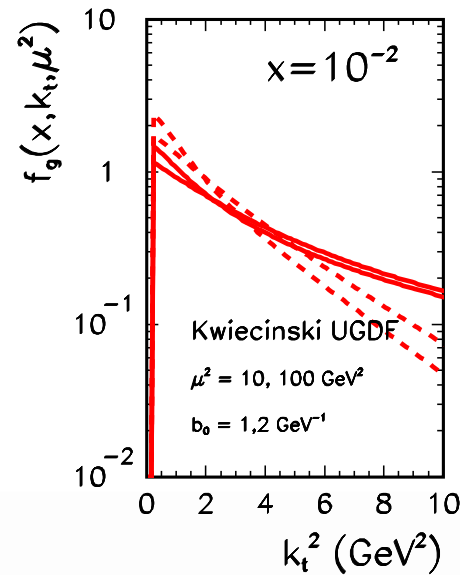
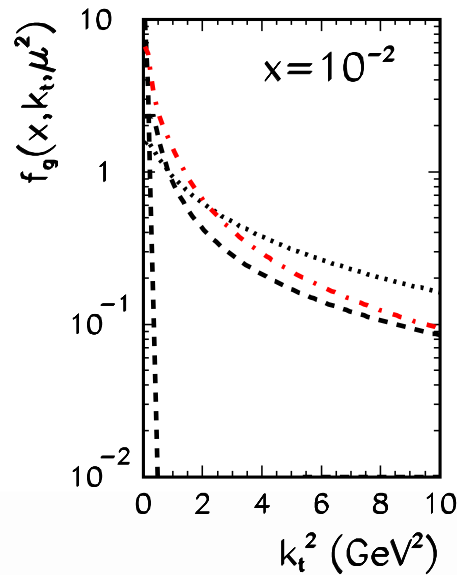
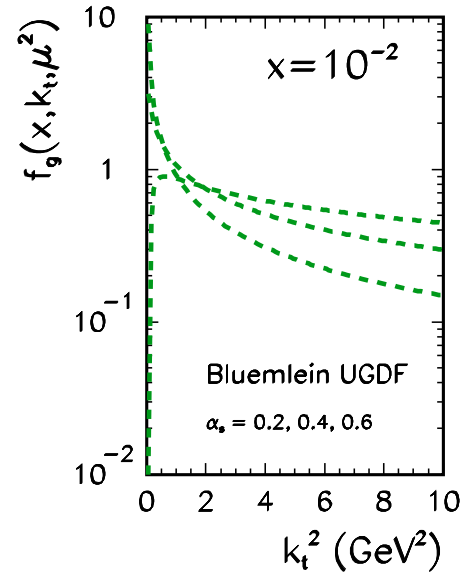
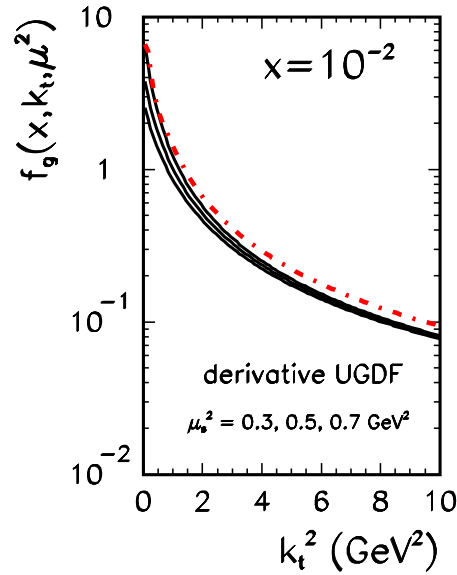



Processes included in our k_t -factorization app

There are 4 important contributions:

- gluon+gluon \rightarrow gluon+gluon (Leonidov-Ostrovsky)
- gluon+gluon \rightarrow quark+antiquark (Leonidov-Ostrovsky)
- gluon+(anti)quark \rightarrow gluon+(anti)quark (new !!!)
- (anti)quark+gluon \rightarrow (anti)quark+gluon (new !!!)

First two processes discussed also by:

Bartels-Sabio-Vera-Schwennsen



New contributions

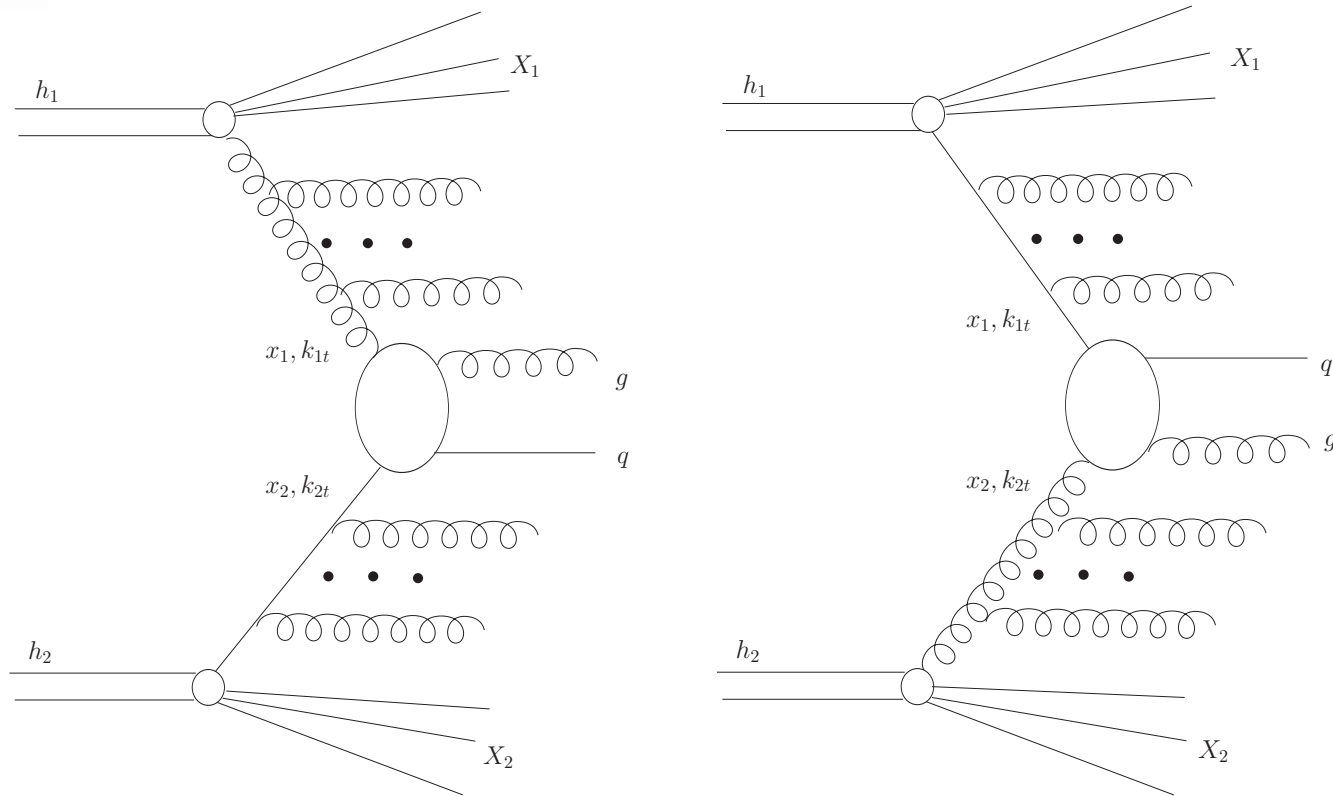
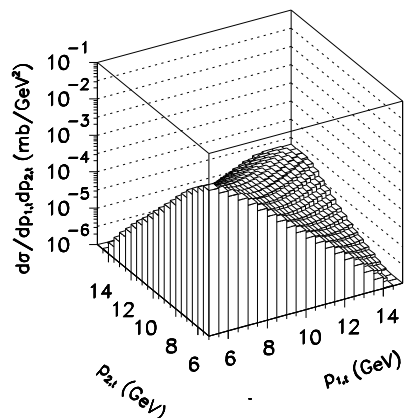
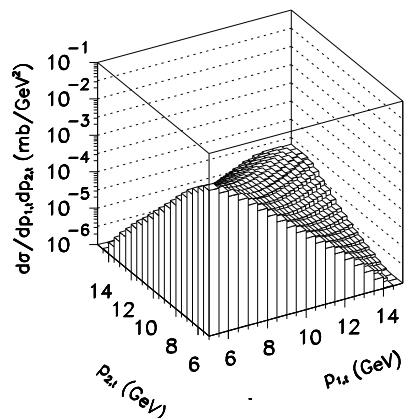
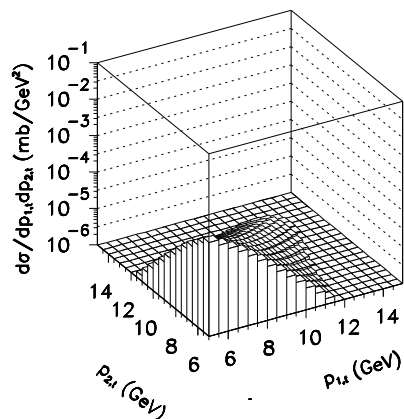
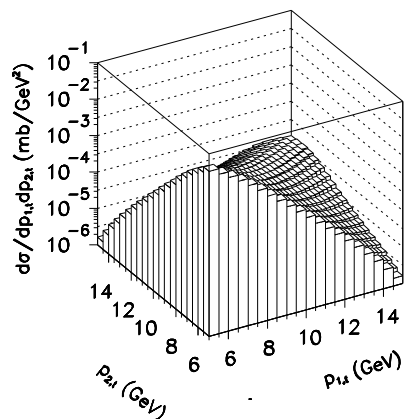

Figure 3:

Processes included in k_t -factorization



$gg \rightarrow gg$ (left upper),
 $gg \rightarrow q\bar{q}$ (right upper),
 $gq \rightarrow gq$ (left lower),
 $qq \rightarrow qq$ (right lower).

Kwieciński UPDFs with $b_0 = 1 \text{ GeV}^{-1}$, $\mu^2 = 100 \text{ GeV}^2$.
 Full range of parton rapidities.

Fractional contributions of different subprocesses

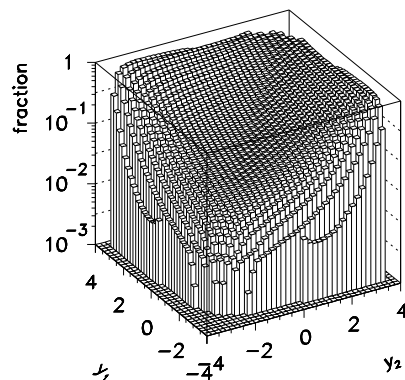
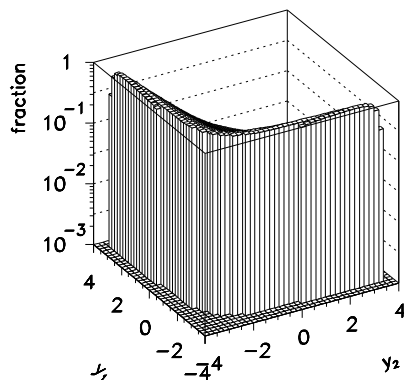
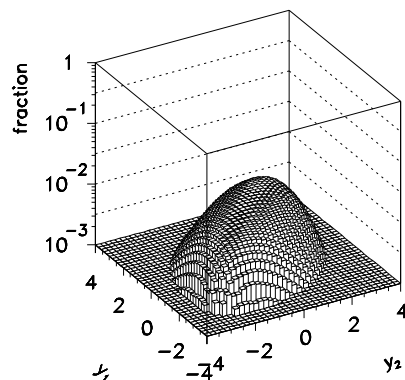
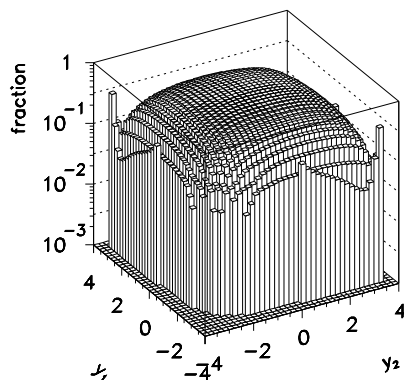

$gg \rightarrow gg$ (left upper),
 $gg \rightarrow q\bar{q}$ (right upper),
 $gq \rightarrow gq$ (left lower),
 $qg \rightarrow qg$ (right lower).

Kwieciński UPDFs with $b_0 = 1 \text{ GeV}^{-1}$, $\mu^2 = 100 \text{ GeV}^2$.
 $5 \text{ GeV} < p_{1t}, p_{2t} < 20 \text{ GeV}$.



Azimuthal correlations

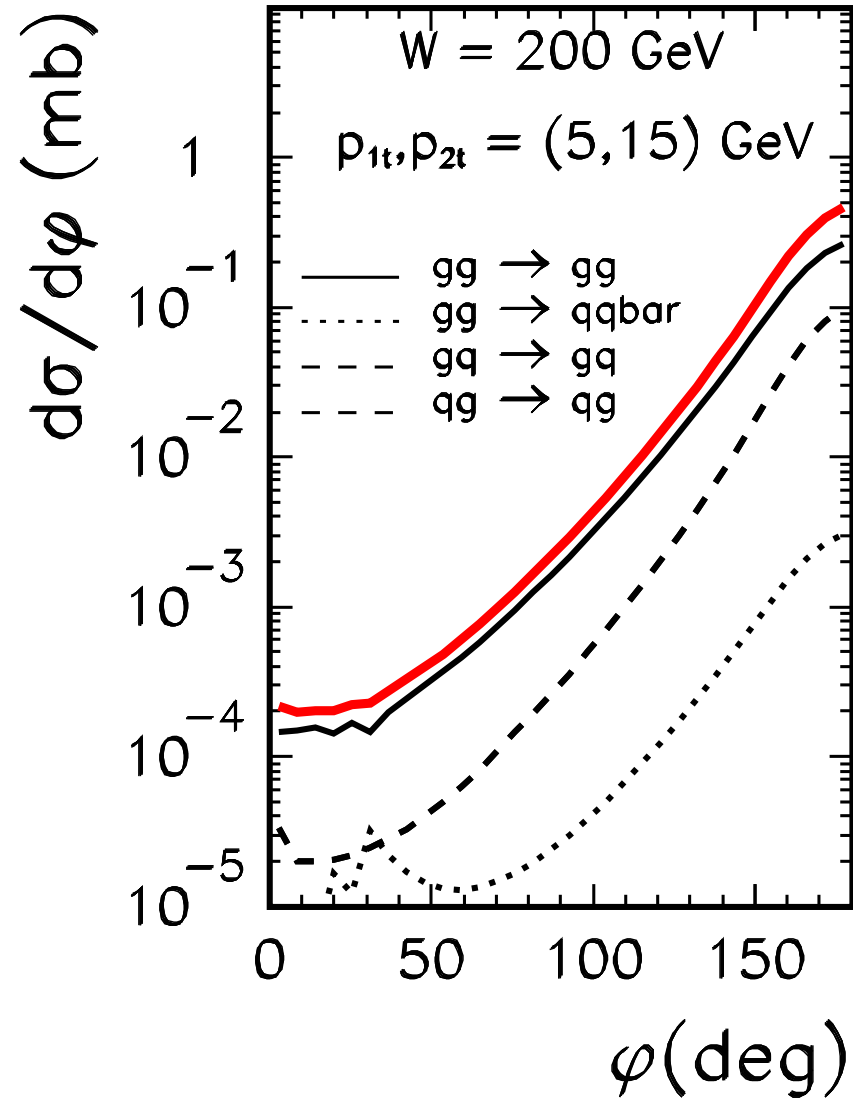



Scales in Kwiecinski UGDF

$\mu^2 = 0.25$ (black), 10 (blue), 100 (red) GeV^2

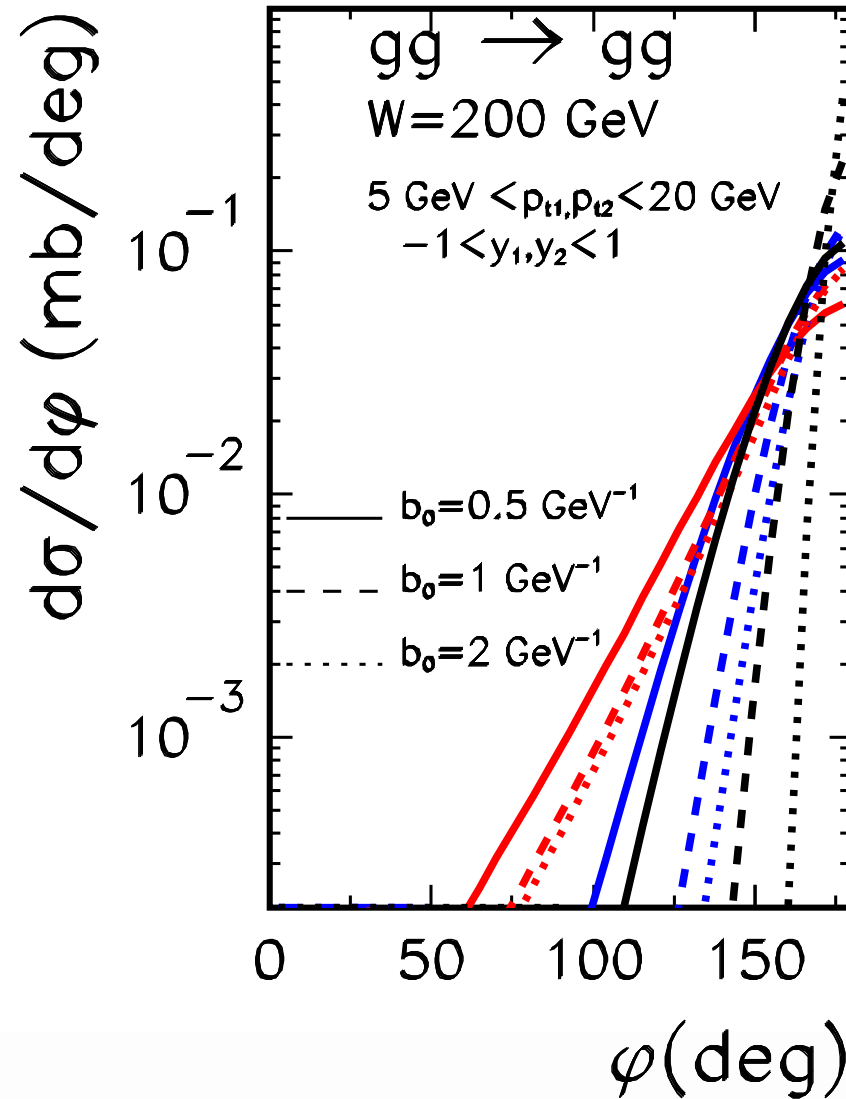



Different UGDFs

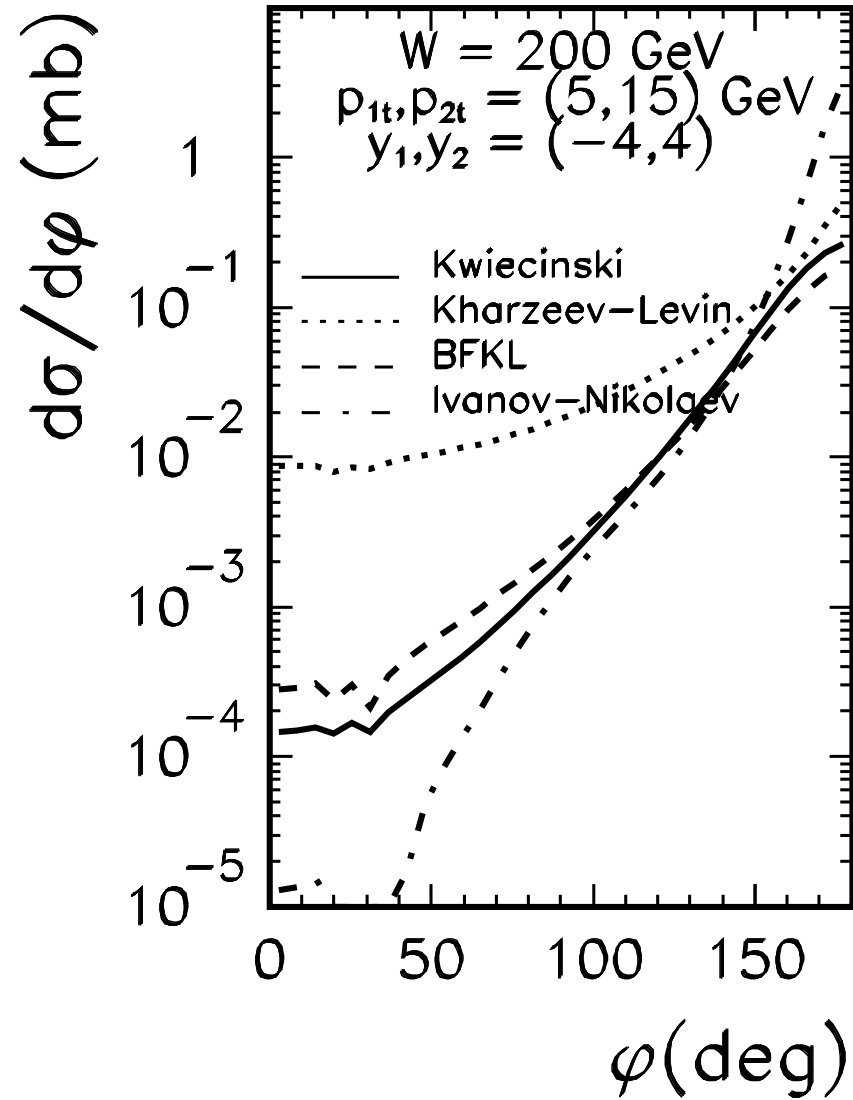



2 \rightarrow 3 processes in collinear approach

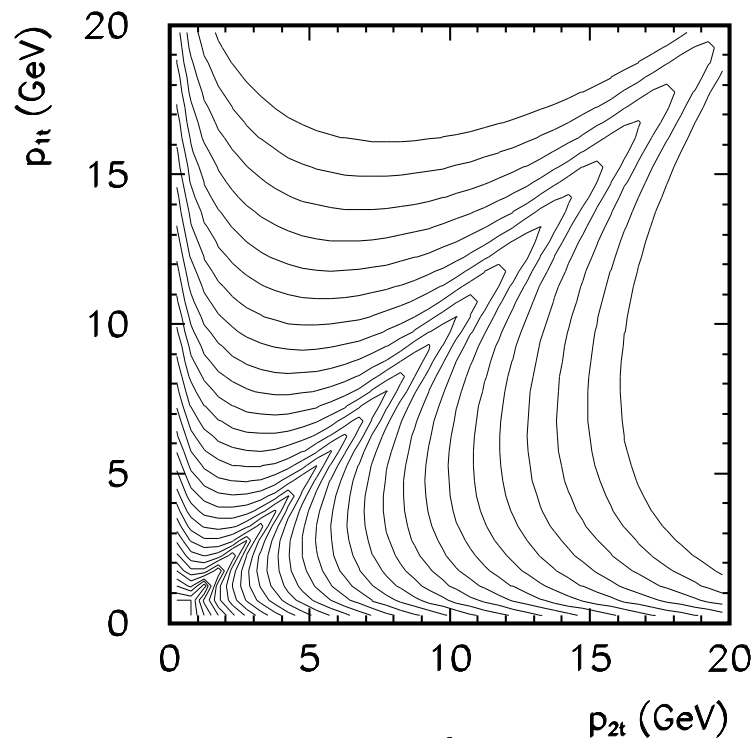
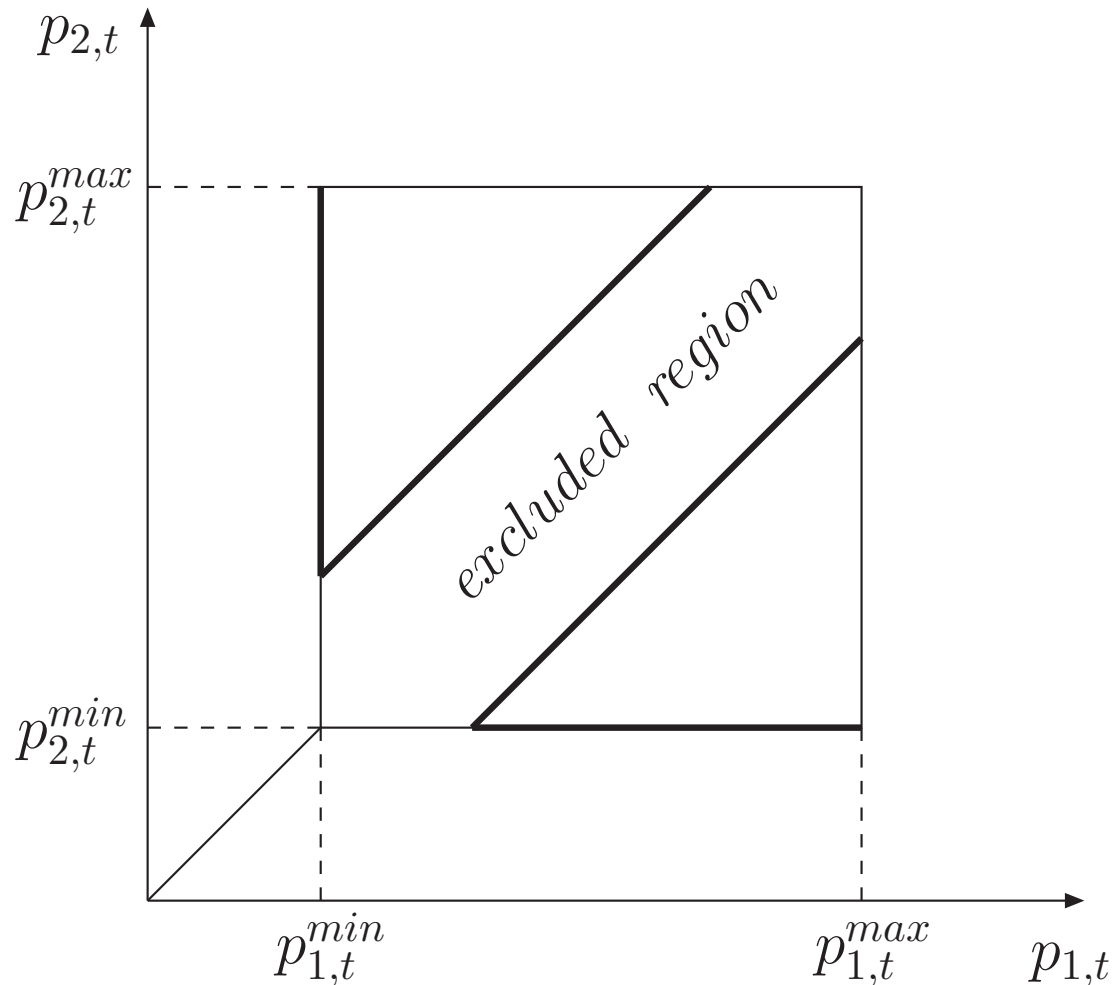

Figure 7: $gg \rightarrow ggg$ component for $W = 200$ GeV.

Singularities when $\vec{p}_1 \rightarrow 0$, $\vec{p}_2 \rightarrow 0$ and $\vec{p}_3 \rightarrow 0$.

How to remove NLO singularities?



k_t -factorization – no singularities, no delta functions !!!



$gg \rightarrow gg$, different UGDFs vs $gg \rightarrow ggg$

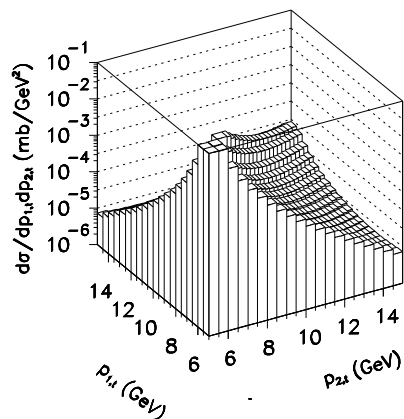
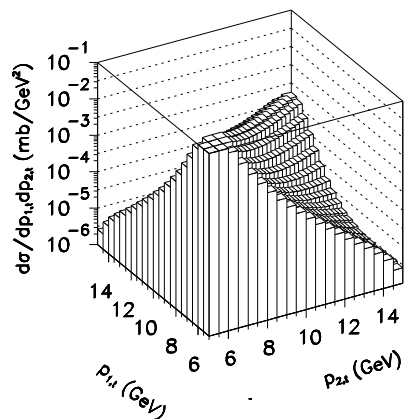
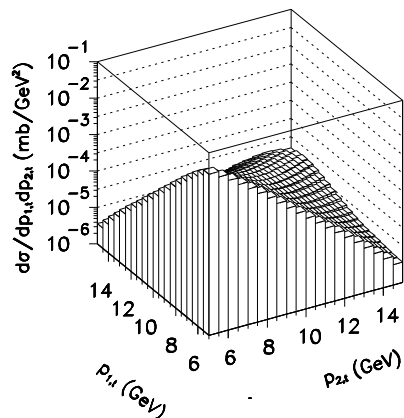
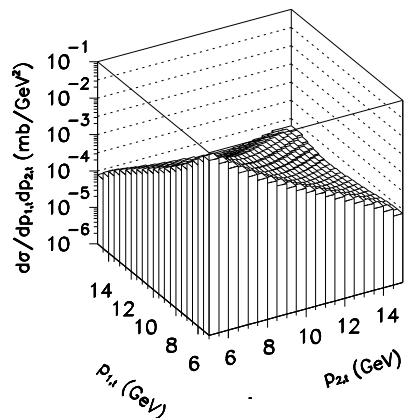

KL (left upper),
BFKL (right upper),
Ivanov-Nikolaev (left lower),
 $gg \rightarrow ggg$ (right lower).

$$-4 < y_1, y_2 < 4.$$



Dijet correlations for $gg \rightarrow ggg$, leading jets

$$p_{1t}(\textit{selected}) > p_{3t} \text{ and } p_{2t}(\textit{selected}) > p_{3t}$$

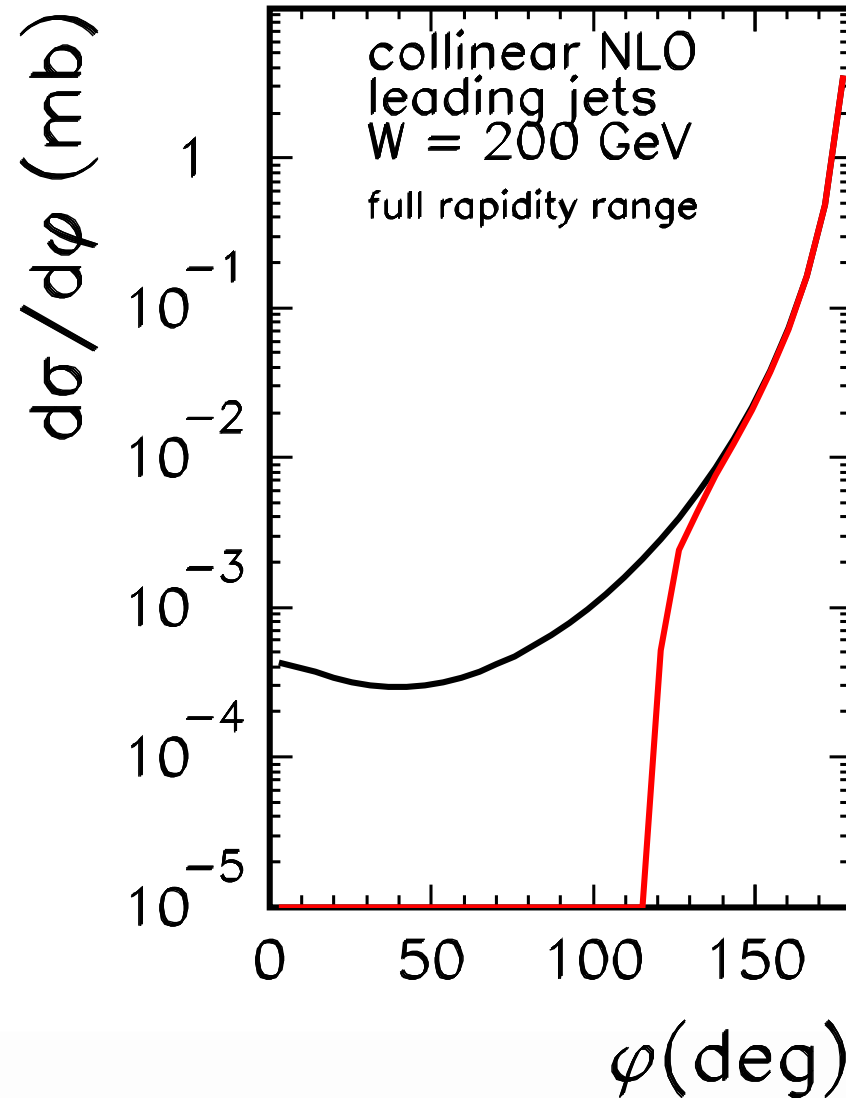



Dijet correlations for $gg \rightarrow ggg$, leading jets

$$p_{1t}(\textit{selected}) > p_{3t} \text{ and } p_{2t}(\textit{selected}) > p_{3t}$$

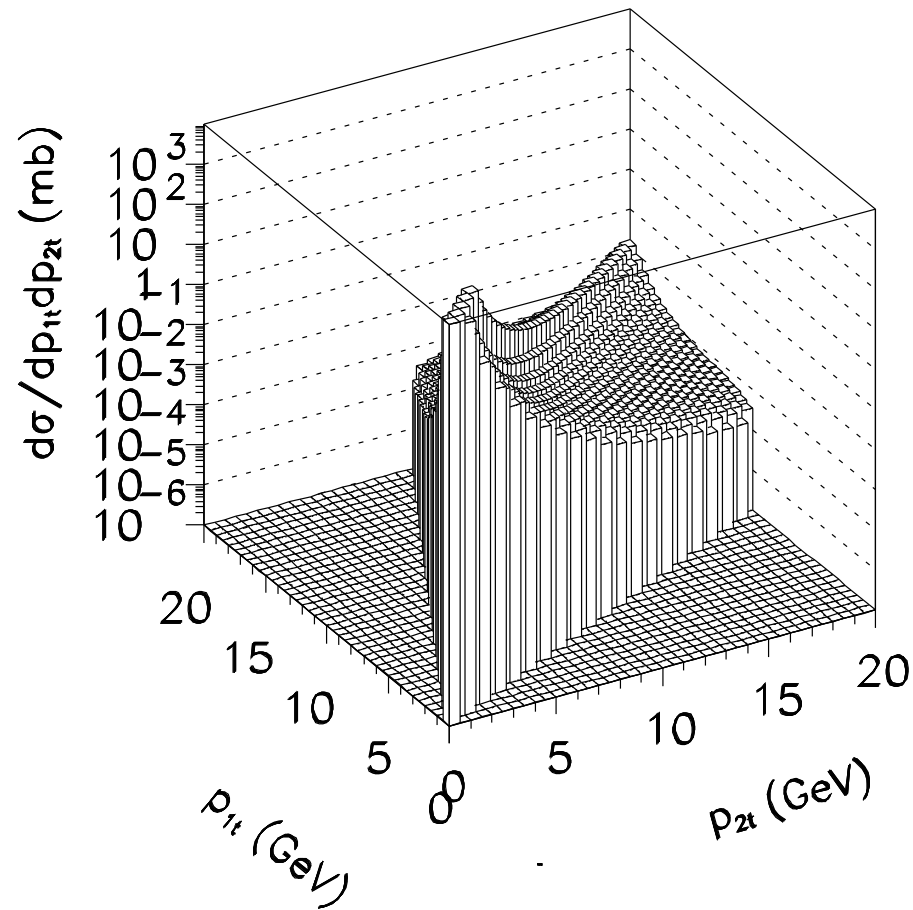

Figure 9:



Windows in p_{1t}, p_{2t}

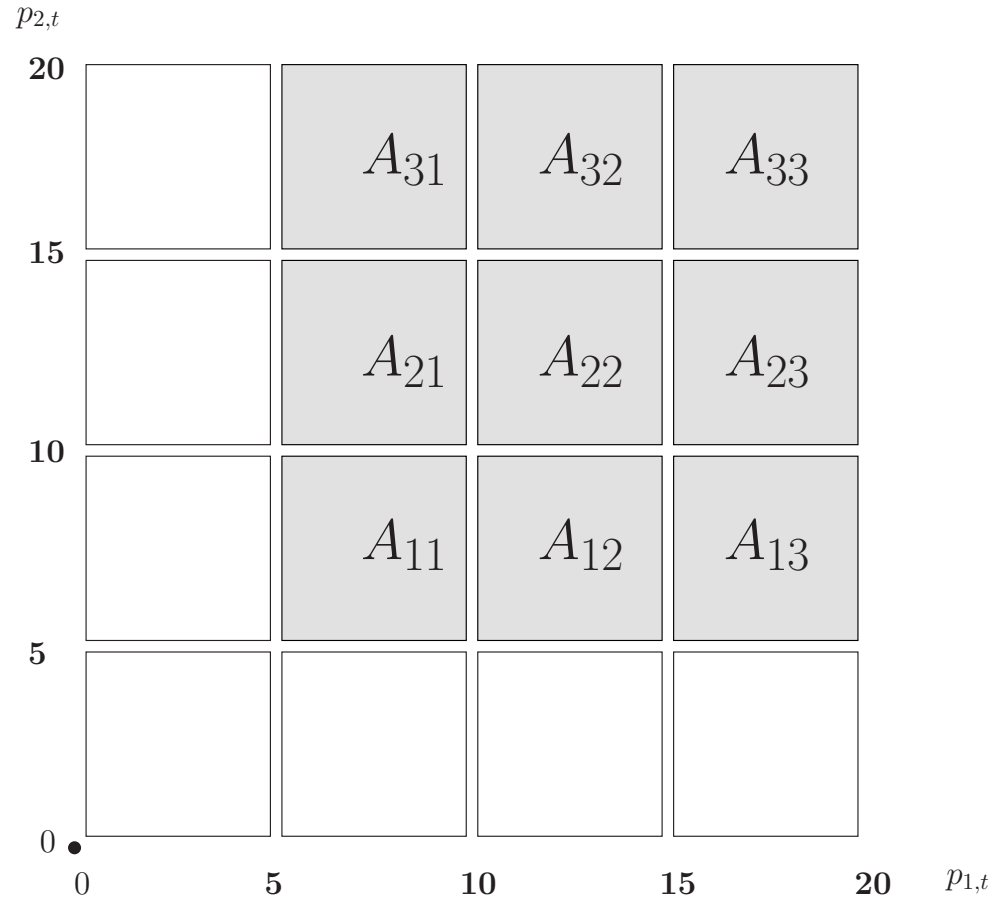

Figure 10: Definition of windows in $p_{1t} \times p_{2t}$ plane.



Windows in p_{1t}, p_{2t}

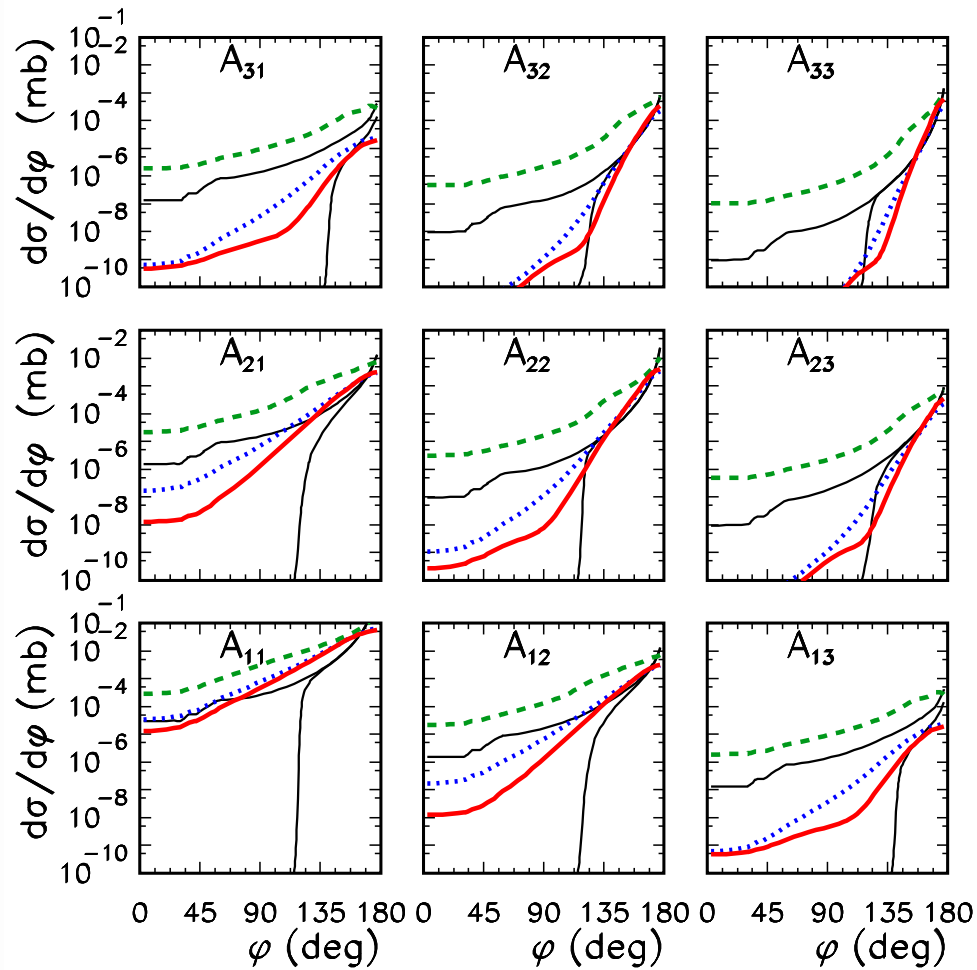

Figure 11:

Extra scalar cuts

- to eliminate LO and NLO singularities (yes!)
- to enhance resummation with respect to NLO (no!)

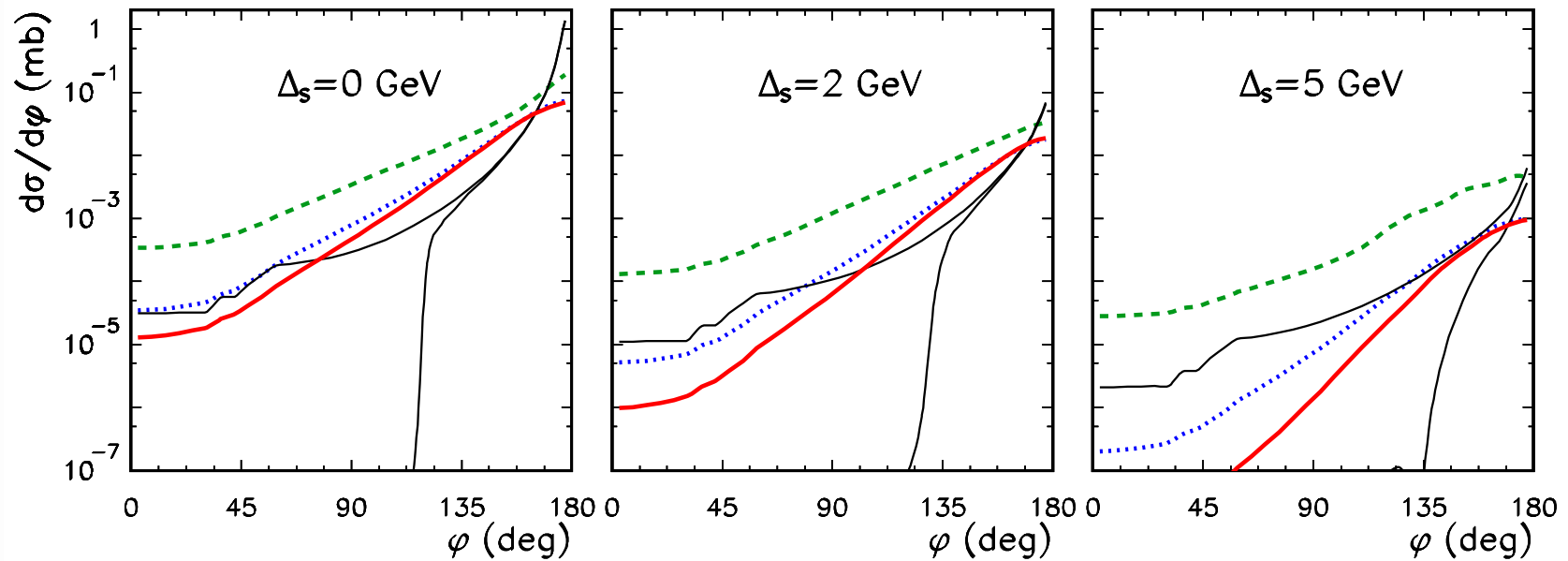

Figure 12: $|p_{1t} - p_{2t}| > \Delta_s$.

Extra vector cuts

- to eliminate LO and NLO singularities (yes!)
- to enhance resummation with respect to NLO (no!)

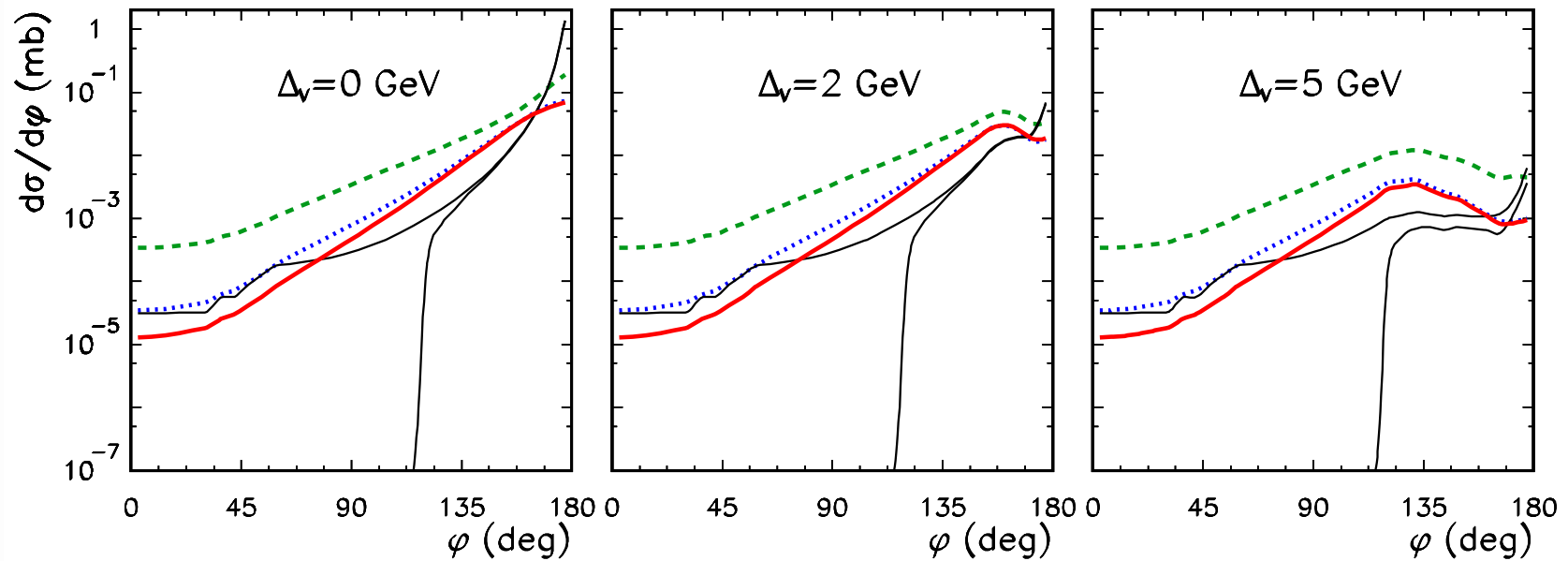

Figure 13: $|\vec{p}_{1t} + \vec{p}_{2t}| > \Delta_v$.



Summary/Conclusions of the first part

- **Dijet correlations** at RHIC have been calculated in the k_t -factorization approach with different UGDFs (UPDFs) from the literature
- **Two new mechanisms** have been included compared to the literature. They are dominant at larger rapidities (or rapidity gaps) i.e. constitute **competition** for **Mueller-Navelet** (BFKL) jets
- Results have been compared with **collinear NLO** calculations
- At $\phi < 120^\circ$ and/or **asymmetric jet transverse momenta** the k_t -factorization is **superior** over the collinear NLO
- This calculation is a **first step** for **hadron-hadron correlations** measured at RHIC. Here internal structure of both jets enters in addition.
- The method can be used in semihard region (small p_t) at LHC.



Photon-jet correlations



Plan of the second part of the talk

- Introduction
- Inclusive spectra
- Photon-jet correlations
- Results
- Conclusions

based partially on:

1) Phys.Rev.D**75**, 014023 (2007)

2) arXiv:hep-ph/0704.2158, Phys. Rev.D**76** 034003

in collaboration with T. Pietrycki



Cascade mechanism 1

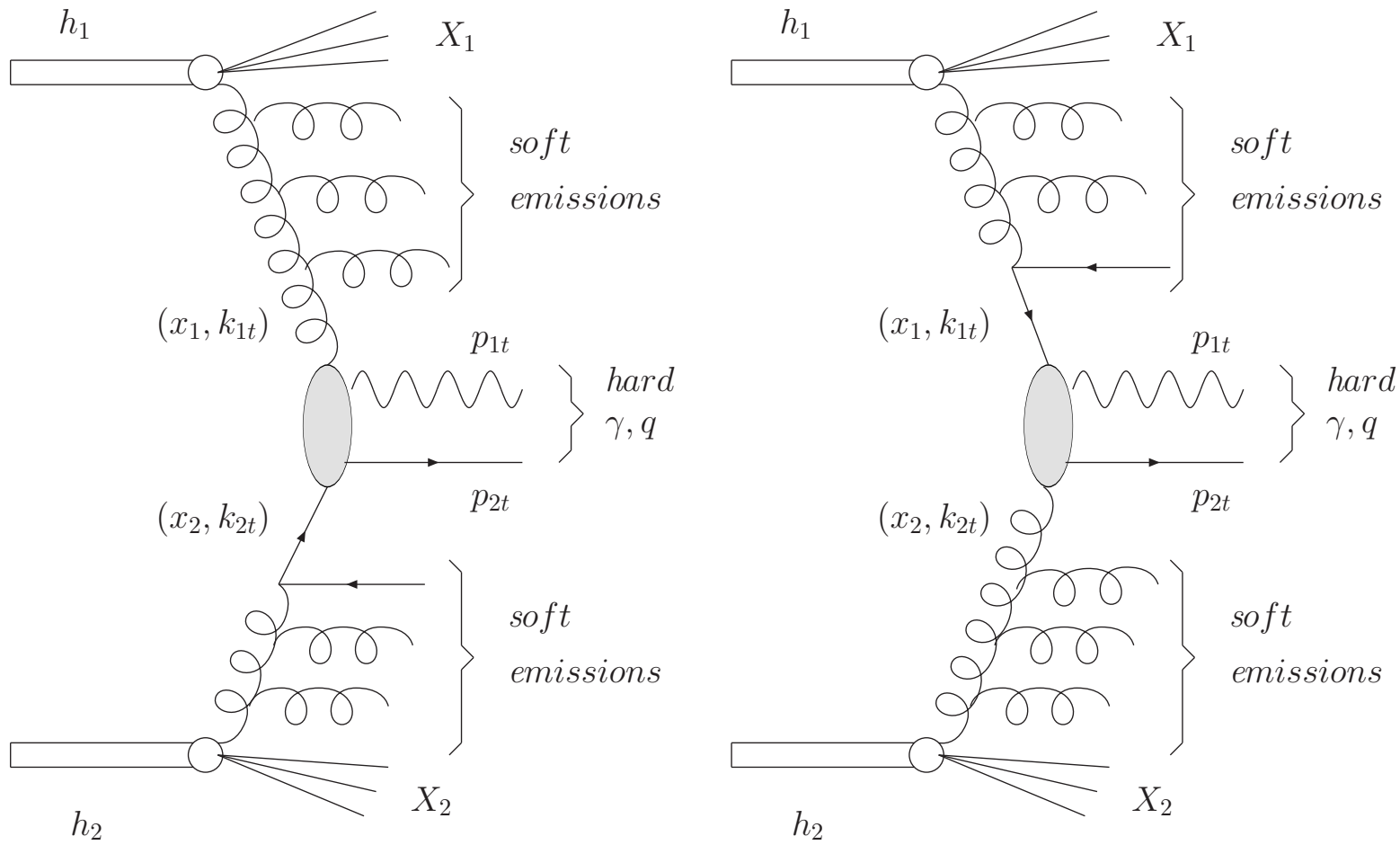



Cascade mechanism 2

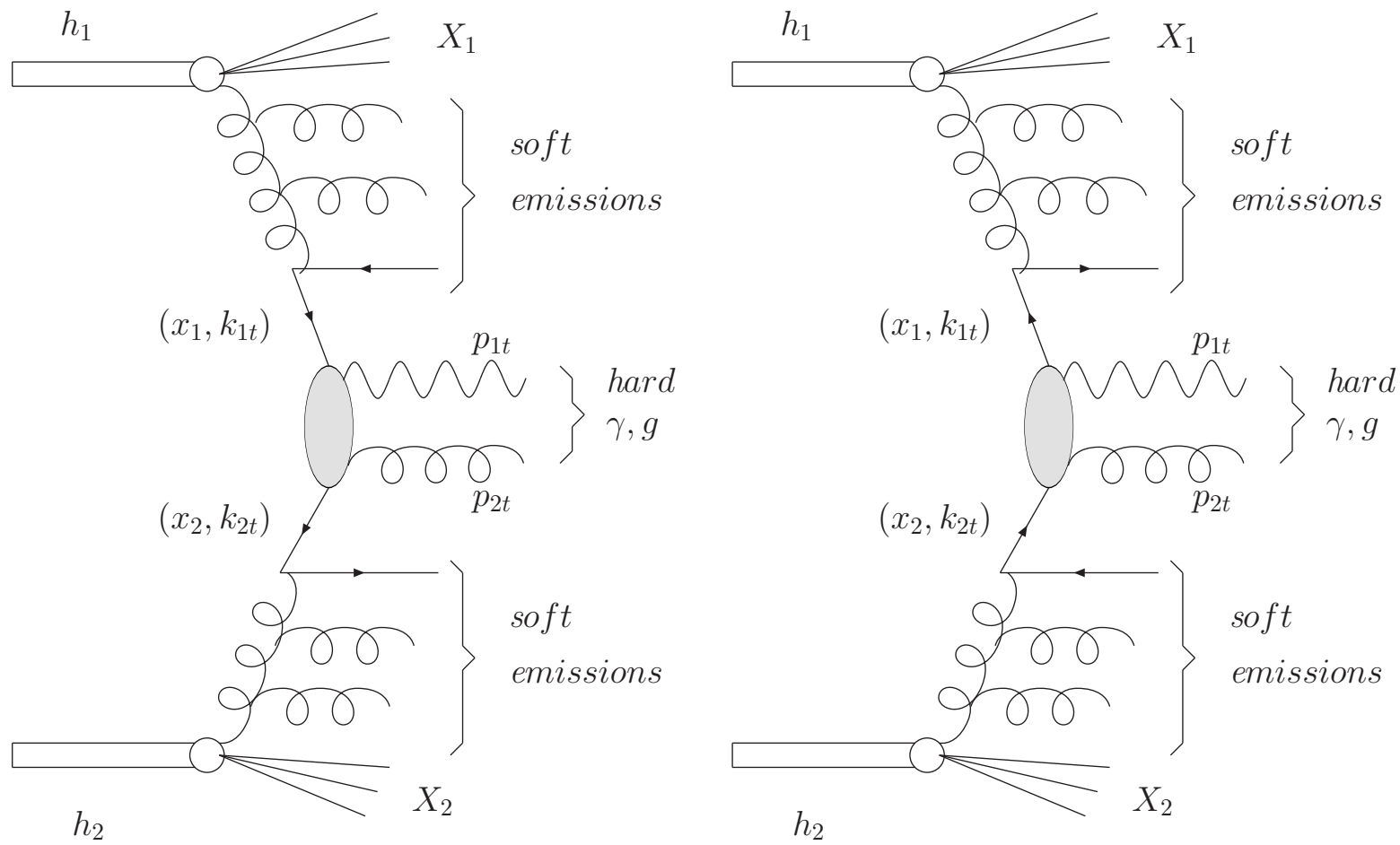



Kimber-Martin-Ryskin for $k_t^2 > k_{t,0}^2$

$$f_q(x, k_t^2, \mu^2) = T_q(k_t^2, \mu^2) \frac{\alpha_s(k_t^2)}{2\pi} \cdot \int_x^1 dz \left[P_{qq}(z) \frac{x}{z} q\left(\frac{x}{z}, k_t^2\right) \Theta(\Delta - z) + P_{qg}(z) \frac{x}{z} g\left(\frac{x}{z}, k_t^2\right) \right]$$

$$f_g(x, k_t^2, \mu^2) = T_g(k_t^2, \mu^2) \frac{\alpha_s(k_t^2)}{2\pi} \cdot \int_x^1 dz \left[P_{gg}(z) \frac{x}{z} g\left(\frac{x}{z}, k_t^2\right) \Theta(\Delta - z) + \sum_q P_{gq}(z) \frac{x}{z} q\left(\frac{x}{z}, k_t^2\right) \right]$$

saturation for $k_t^2 < k_{t,0}^2$

UPDFs and photon production

$$\frac{d\sigma(h_1 h_2 \rightarrow \gamma, \text{parton})}{d^2 p_{1,t} d^2 p_{2,t}} = \int dy_1 dy_2 \frac{d^2 k_{1,t}}{\pi} \frac{d^2 k_{2,t}}{\pi} \frac{1}{16\pi^2 (x_1 x_2 s)^2} \sum_{i,j,k} \overline{|M(ij \rightarrow \gamma k)|^2} \cdot \delta^2(\vec{k}_{1,t} + \vec{k}_{2,t} - \vec{p}_{1,t} - \vec{p}_{2,t}) f_i(x_1, k_{1,t}^2) f_j(x_2, k_{2,t}^2)$$

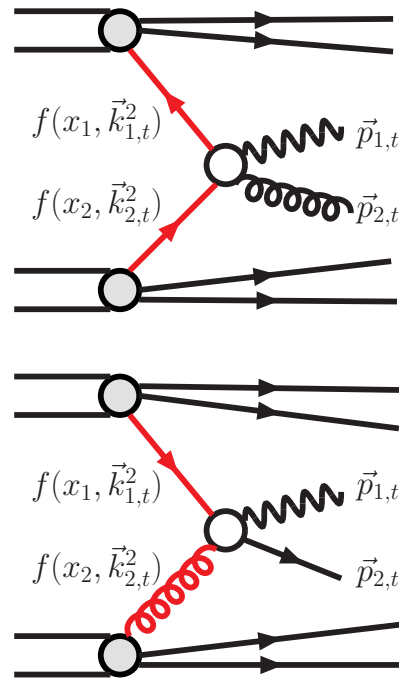
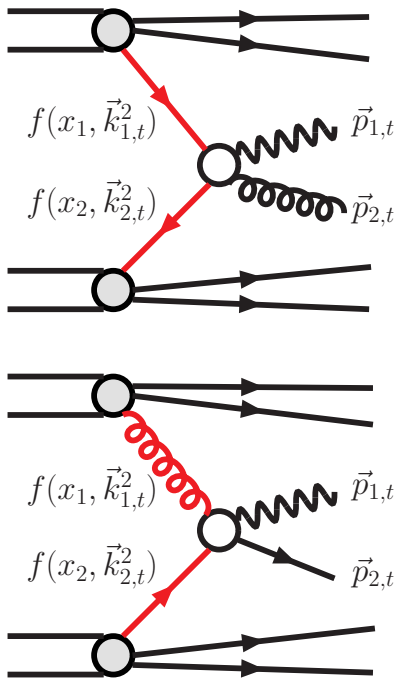

$$(i, j, k) = (q, \bar{q}, g), (\bar{q}, q, g), (g, \bar{q}, q), (q, g, q)$$

standard formula

collinear

$$f_i(x_1, k_{1,t}^2) \rightarrow x_1 p_i(x_1) \delta(k_{1,t}^2)$$

$$f_j(x_2, k_{2,t}^2) \rightarrow x_2 p_j(x_2) \delta(k_{2,t}^2)$$



Differential cross section

2 \rightarrow 2 in k_t -factorization approach

$$d\sigma_{h_1 h_2 \rightarrow \gamma, k} = dy_1 dy_2 d^2 p_{1,t} d^2 p_{2,t} \frac{d^2 k_{1,t}}{\pi} \frac{d^2 k_{2,t}}{\pi} \frac{1}{16\pi^2 (x_1 x_2 s)^2} \sum_{i,j,k} \overline{|M_{ij \rightarrow \gamma k}|^2} \\ \cdot f_i(x_1, k_{1,t}^2) f_j(x_2, k_{2,t}^2) \delta^2(\vec{k}_{1,t} + \vec{k}_{2,t} - \vec{p}_{1,t} - \vec{p}_{2,t})$$

2 \rightarrow 3 in **collinear**-factorization approach

$$d\sigma_{h_1 h_2 \rightarrow \gamma kl} = dy_1 dy_2 dy_3 d^2 p_{1,t} d^2 p_{2,t} \frac{1}{(4\pi)^3 (2\pi)^2} \frac{1}{\hat{s}^2} \sum_{i,j,k,l} \overline{|M_{ij \rightarrow \gamma kl}|^2} \\ \cdot x_1 p_i(x_1, \mu^2) x_2 p_j(x_2, \mu^2)$$

see Aurenche et al., Nucl. Phys. **B286** 553 (87)



Photon-jet correlations $d\sigma/d\phi_-$

2 \rightarrow 2 in k_t -factorization approach

$$\frac{d\sigma_{h_1 h_2 \rightarrow \gamma k}}{d\phi_-} = \int \frac{2\pi}{16\pi^2(x_1 x_2 s)^2} \frac{f_i(x_1, k_{1,t}^2)}{\pi} \frac{f_j(x_2, k_{2,t}^2)}{\pi} \sum_{i,j,k} \overline{|M_{ij \rightarrow \gamma k}|^2} \\ \cdot p_{1,t} dp_{1,t} p_{2,t} dp_{2,t} dy_1 dy_2 q_t dq_t d\phi_{qt}$$

2 \rightarrow 3 in **collinear**-factorization approach

$$\frac{d\sigma_{h_1 h_2 \rightarrow \gamma kl}}{d\phi_-} = \int \frac{1}{64\pi^4 \hat{s}^2} x_1 p_i(x_1, \mu^2) x_2 p_j(x_2, \mu^2) \sum_{i,j,k,l} \overline{|M_{ij \rightarrow \gamma kl}|^2} \\ \cdot p_{1,t} dp_{1,t} p_{2,t} dp_{2,t} dy_1 dy_2 dy_3$$



Decorrelations in $(p_{1,t}, p_{2,t})$ space

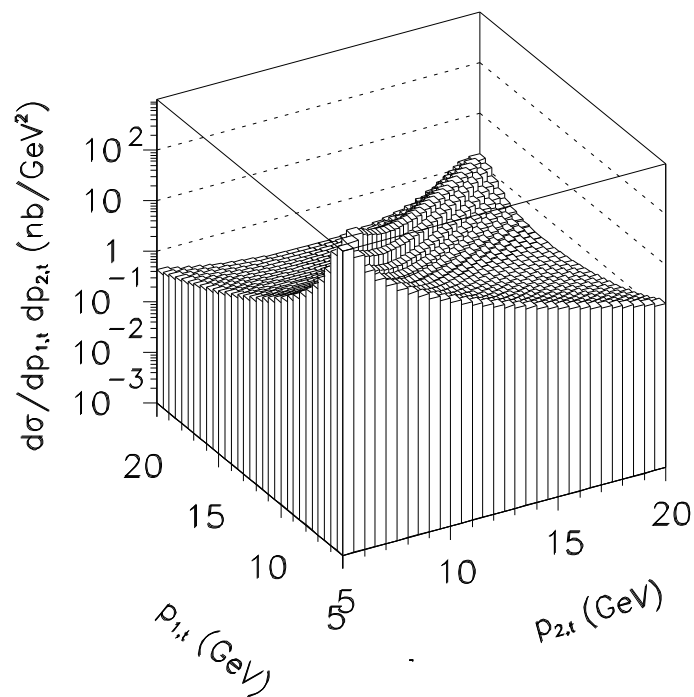
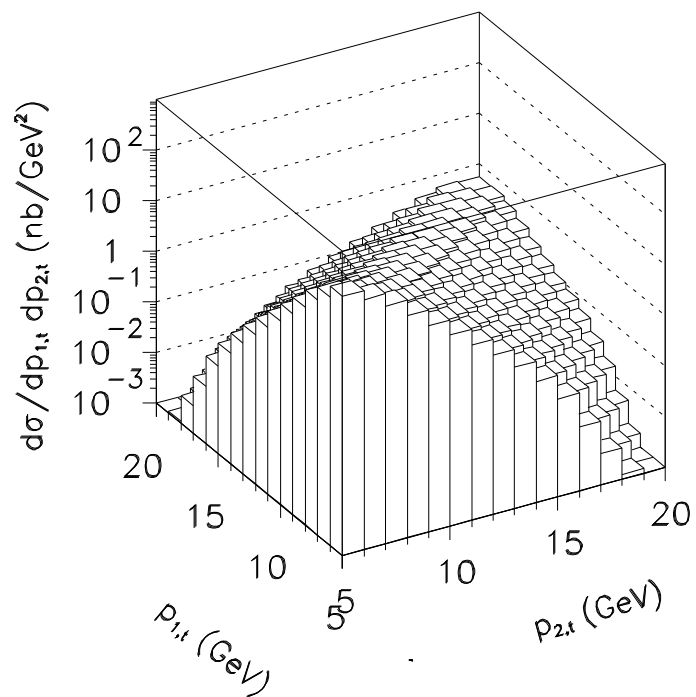



Scale dependence in Kwieciński UPDFs

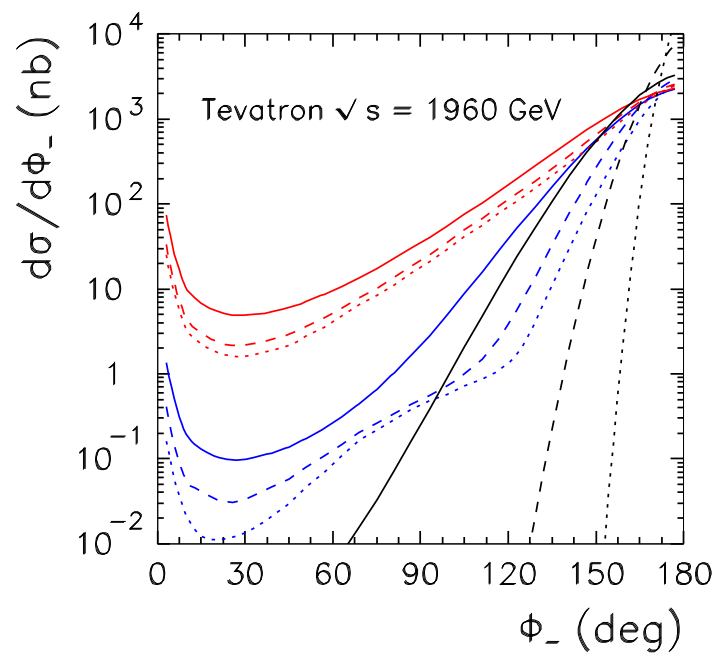
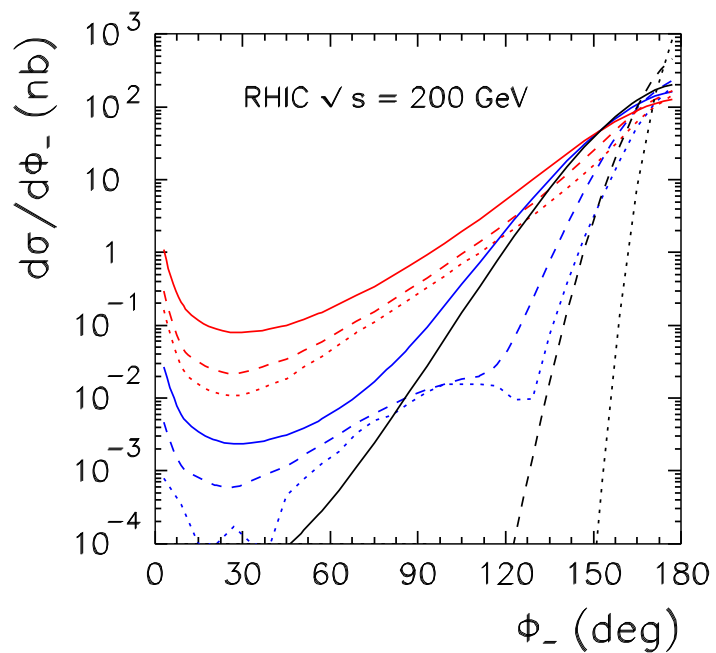



Photon-jet correlations $d\sigma/d\phi_-$

NLO collinear vs k_t -factorization approach

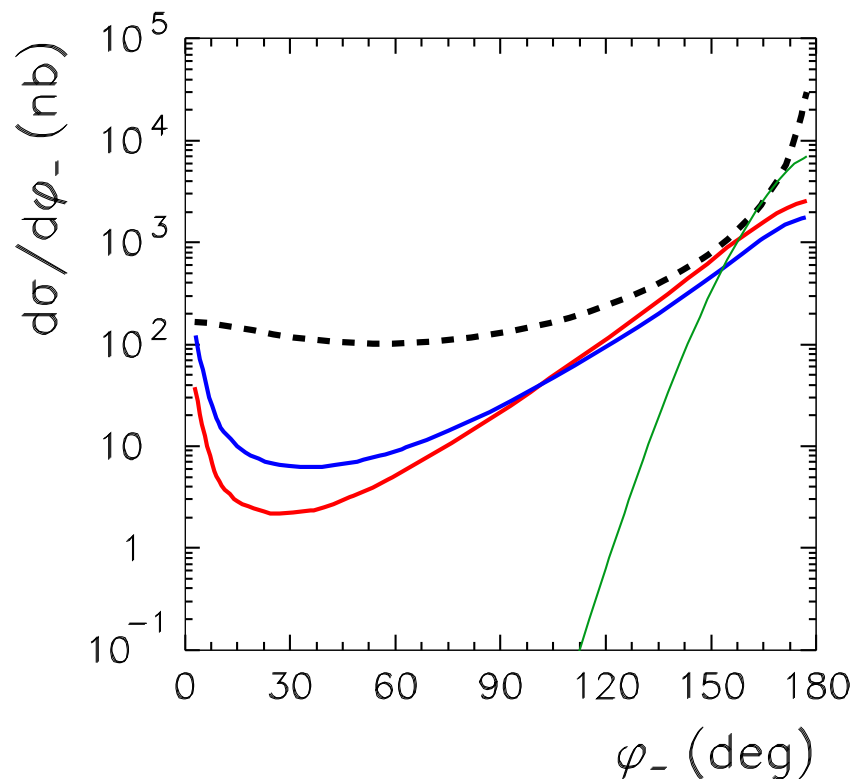

$$\sqrt{s} = 1960 \text{ GeV}$$

$$p_{1,t}, p_{2,t} \in (5, 20) \text{ GeV}$$

$$y_1, y_2, y_3 \in (-4, 4)$$

NLO collinear

Gauss $\sigma_0 = 1 \text{ GeV}$

KMR $k_{t0}^2 = 1 \text{ GeV}^2$

Kwieciński $b_0 = 1/ \text{ GeV}$



Scalar cuts

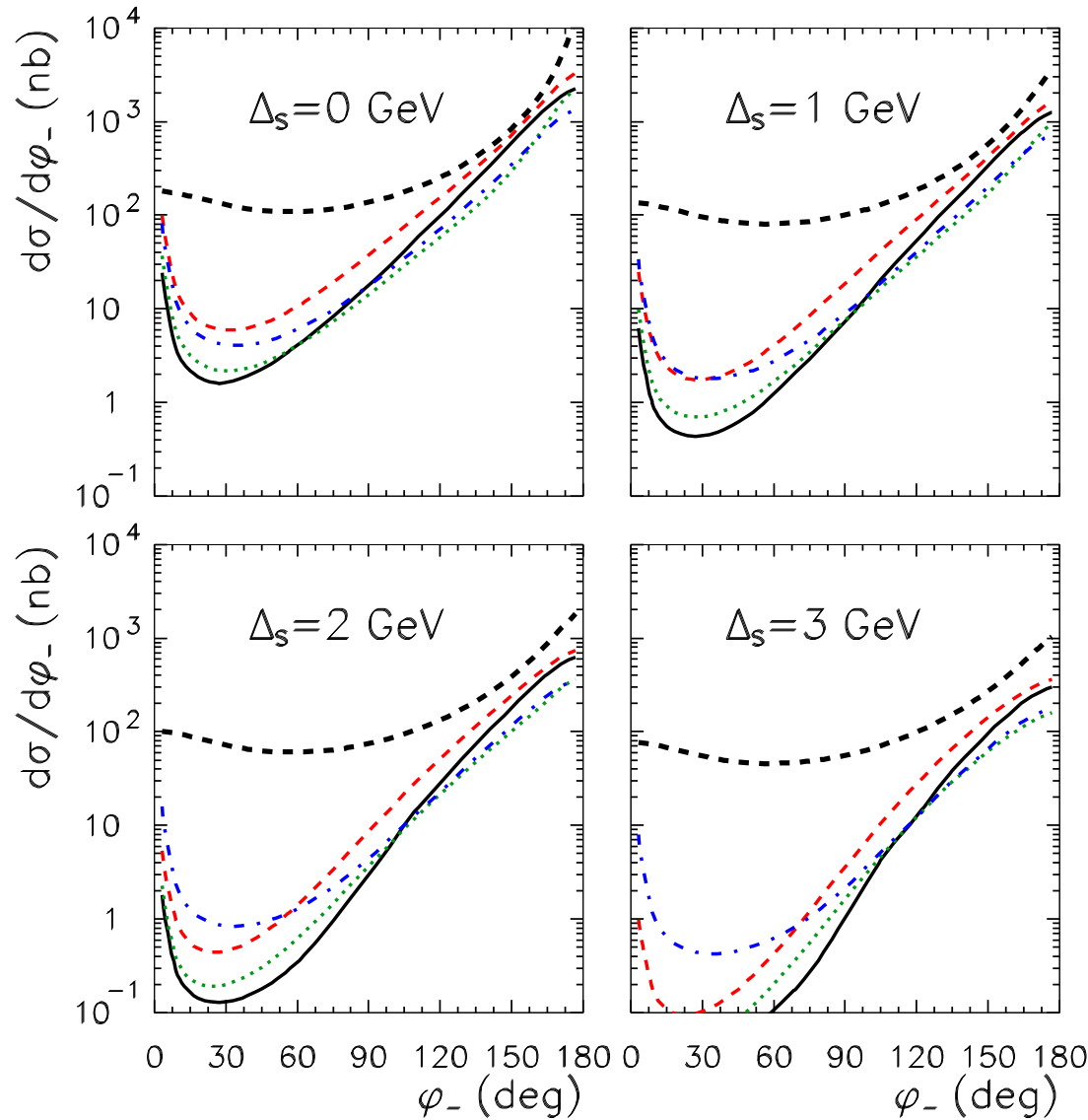

$$|p_{1,t} - p_{2,t}| > \Delta_S$$

$$\sqrt{s} = 1960 \text{ GeV}$$

$$p_{1,t}, p_{2,t} \in (5, 20) \text{ GeV}$$

$$y_1, y_2, y_3 \in (-4, 4)$$

NLO collinear

Gauss

$$\sigma_0 = 1 \text{ GeV}$$

KMR

$$k_{t0}^2 = 1 \text{ GeV}^2$$

Kwieciński

$$b_0 = 1 / \text{GeV}$$

Vector cuts

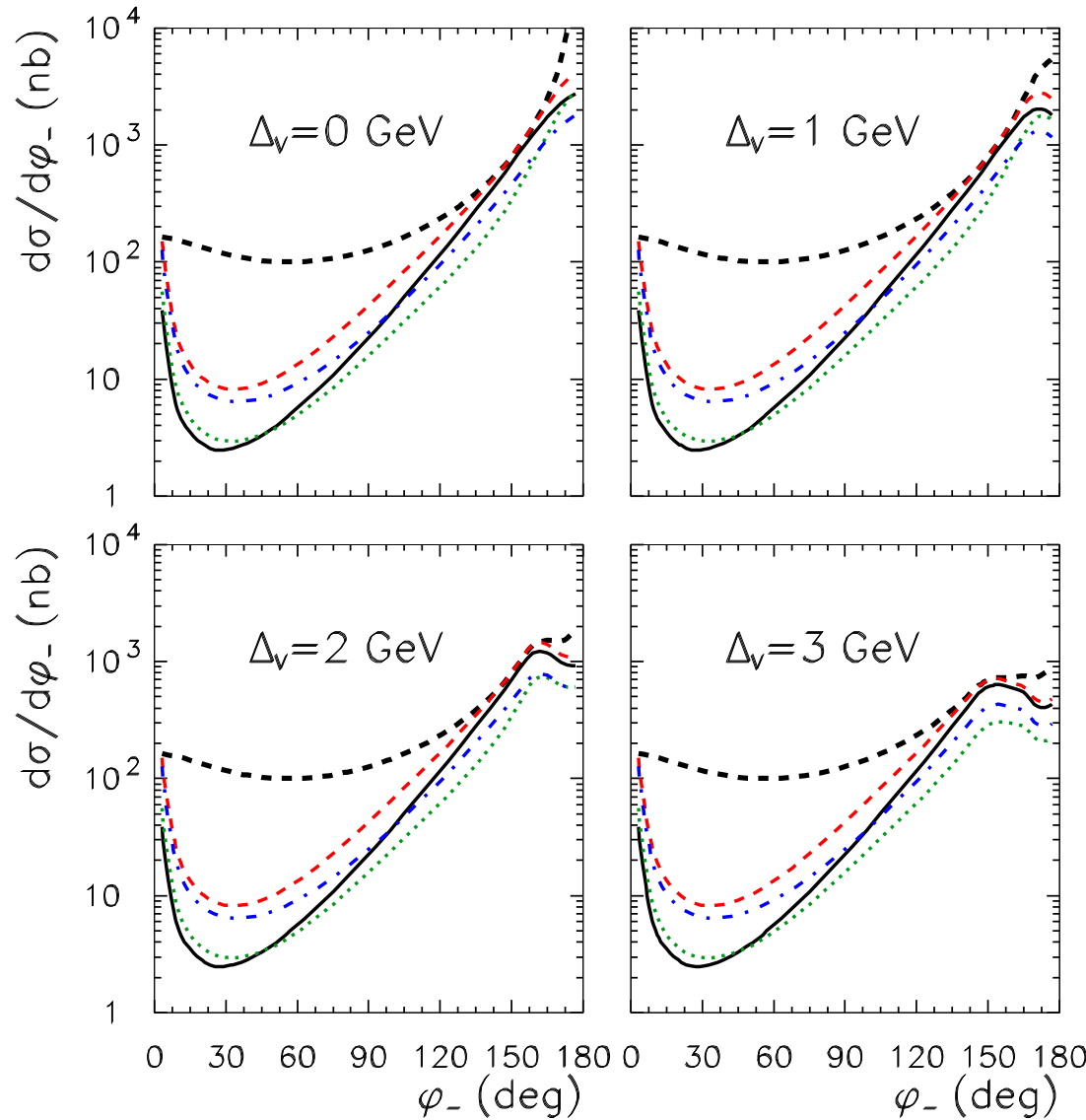

$$|\vec{p}_{1,t} + \vec{p}_{2,t}| > \Delta_V$$

$$\sqrt{s} = 1960 \text{ GeV}$$

$$p_{1,t}, p_{2,t} \in (5, 20) \text{ GeV}$$

$$y_1, y_2, y_3 \in (-4, 4)$$

NLO collinear

Gauss

$$\sigma_0 = 1 \text{ GeV}$$

KMR

$$k_{t0}^2 = 1 \text{ GeV}^2$$

Kwieciński

$$b_0 = 1 / \text{GeV}$$



Leading photon/jet

NLO collinear

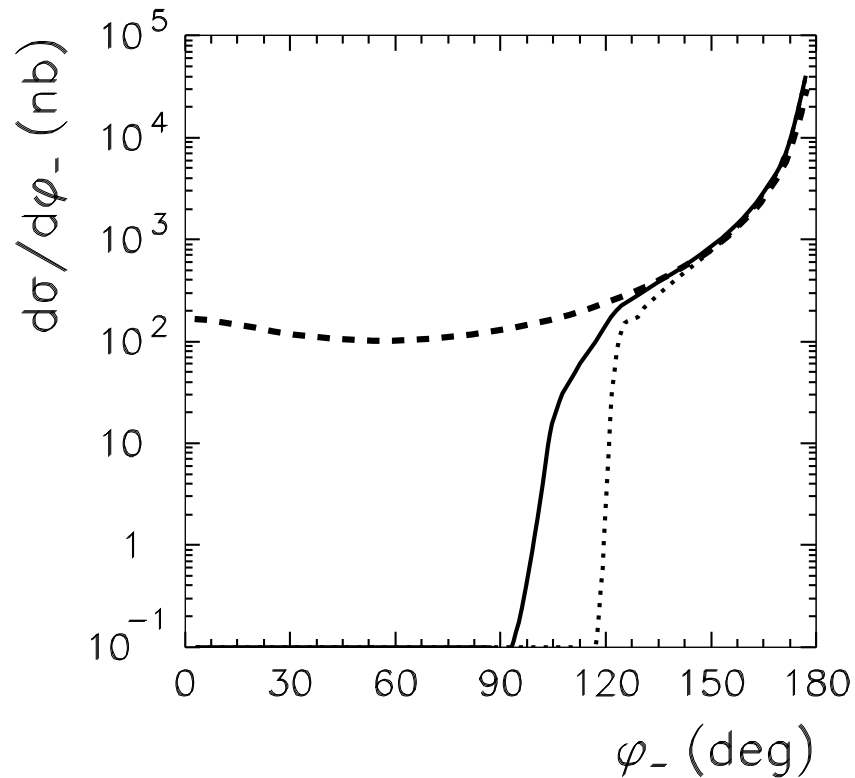

(dashed) no limits on $p_{3,t}$

(solid) $p_{3,t} < p_{2,t}$

(dotted) $p_{3,t} < p_{1,t}$
 $p_{3,t} < p_{2,t}$

$$\sqrt{s} = 1960 \text{ GeV}$$

$$p_{1,t}, p_{2,t} \in (5, 20) \text{ GeV}$$

$$y_1, y_2, y_3 \in (-4, 4)$$

$p_{1,t}$ - photon

$p_{2,t}$ - observed parton

$p_{3,t}$ - unobs. parton

NLO collinear versus k_t -factorization

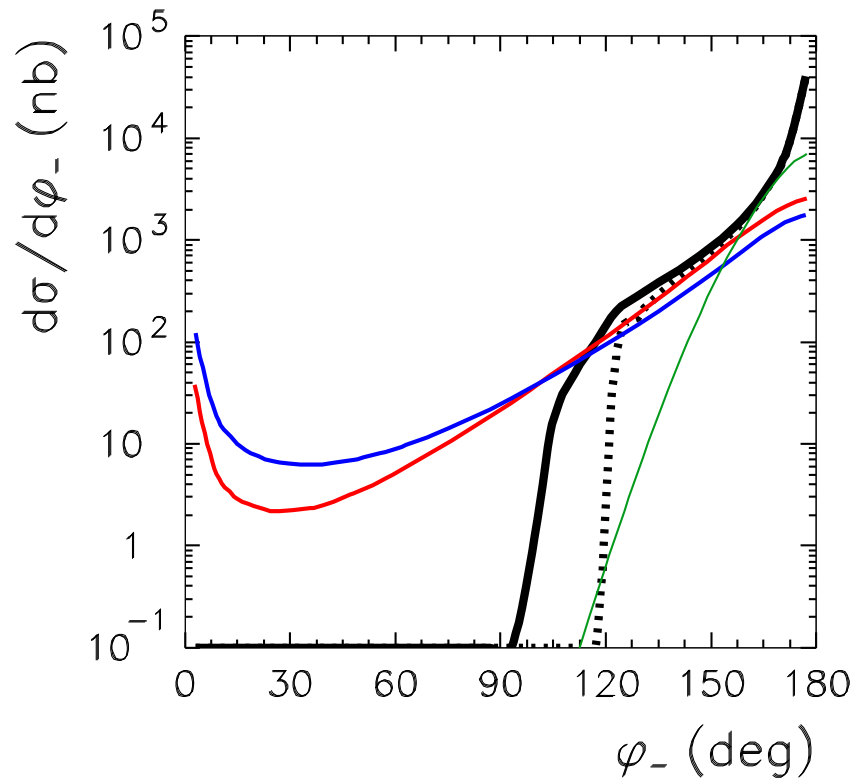

(solid) $p_{3,t} < p_{2,t}$

(dotted) $p_{3,t} < p_{1,t}$
 $p_{3,t} < p_{2,t}$

$$\sqrt{s} = 1960 \text{ GeV}$$

$$p_{1,t}, p_{2,t} \in (5, 20) \text{ GeV}$$

$$y_1, y_2, y_3 \in (-4, 4)$$

$p_{1,t}$ - photon

$p_{2,t}$ - observed parton

$p_{3,t}$ - unobs. parton



Leading photon/jet in $(p_{1,t}, p_{2,t})$ space

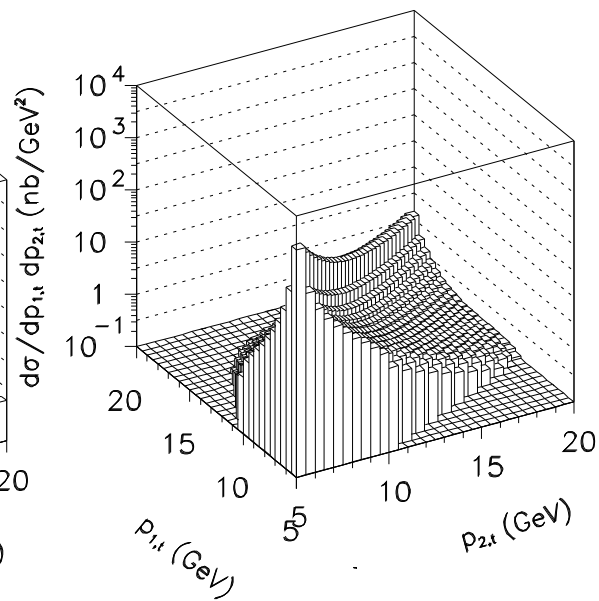
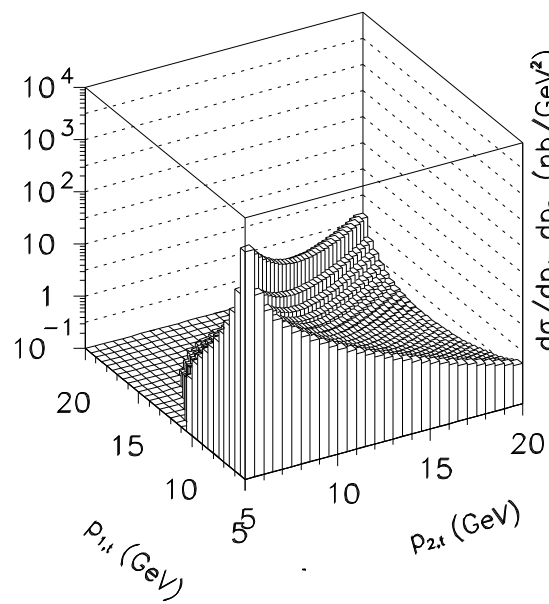
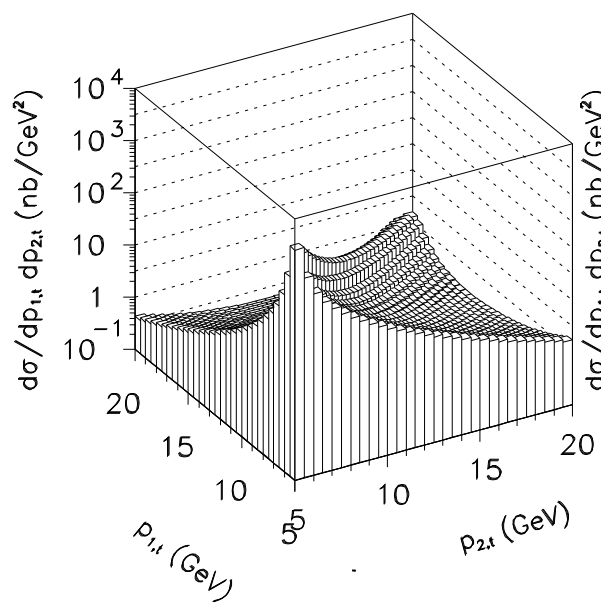

no limits on $p_{3,t}$

$$p_{3,t} < p_{2,t}$$

$$p_{3,t} < p_{1,t}$$

$$p_{3,t} < p_{2,t}$$



Windows in $(p_{1,t}, p_{2,t})$

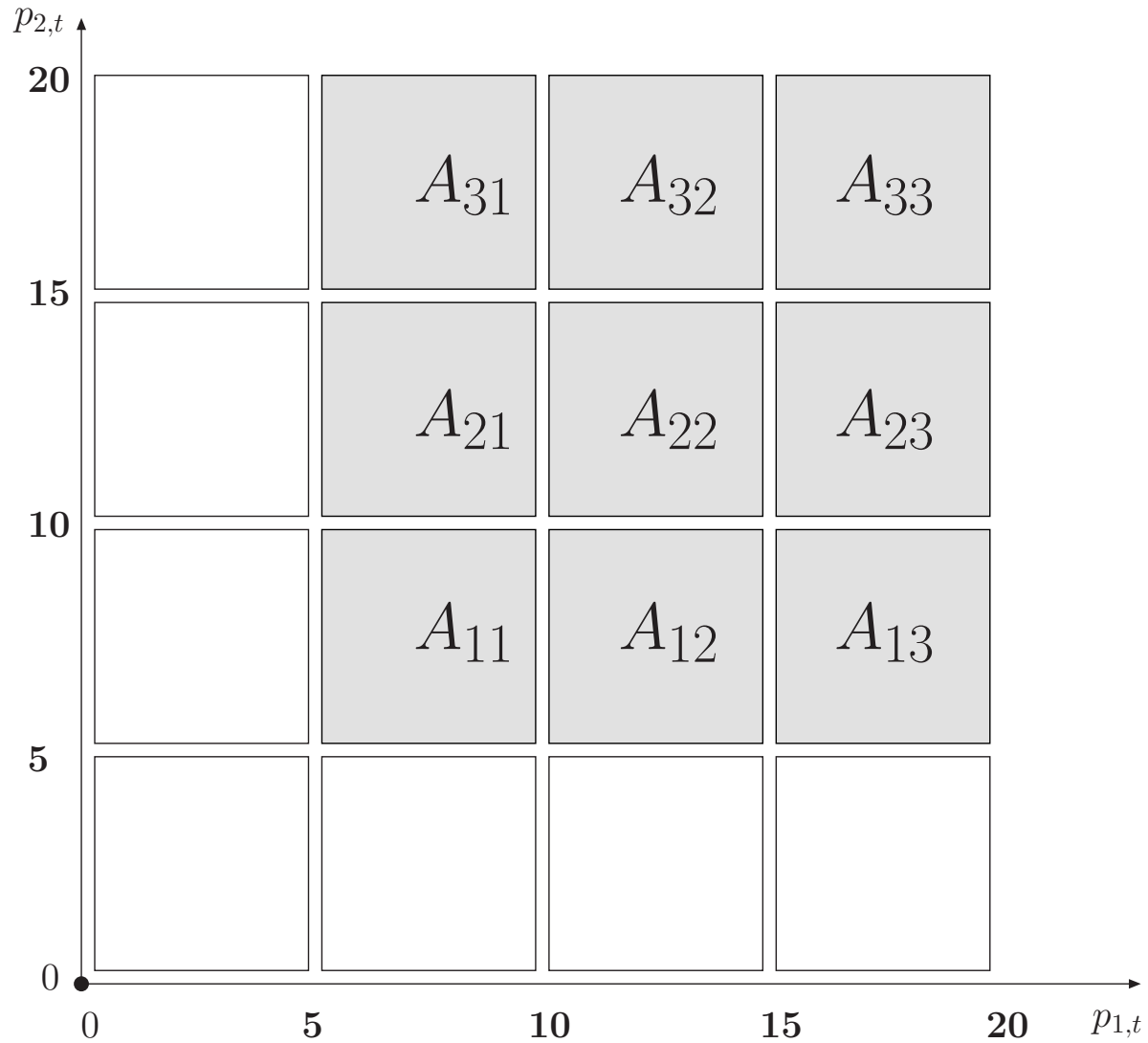



Windows in $(p_{1,t}, p_{2,t})$ - RHIC

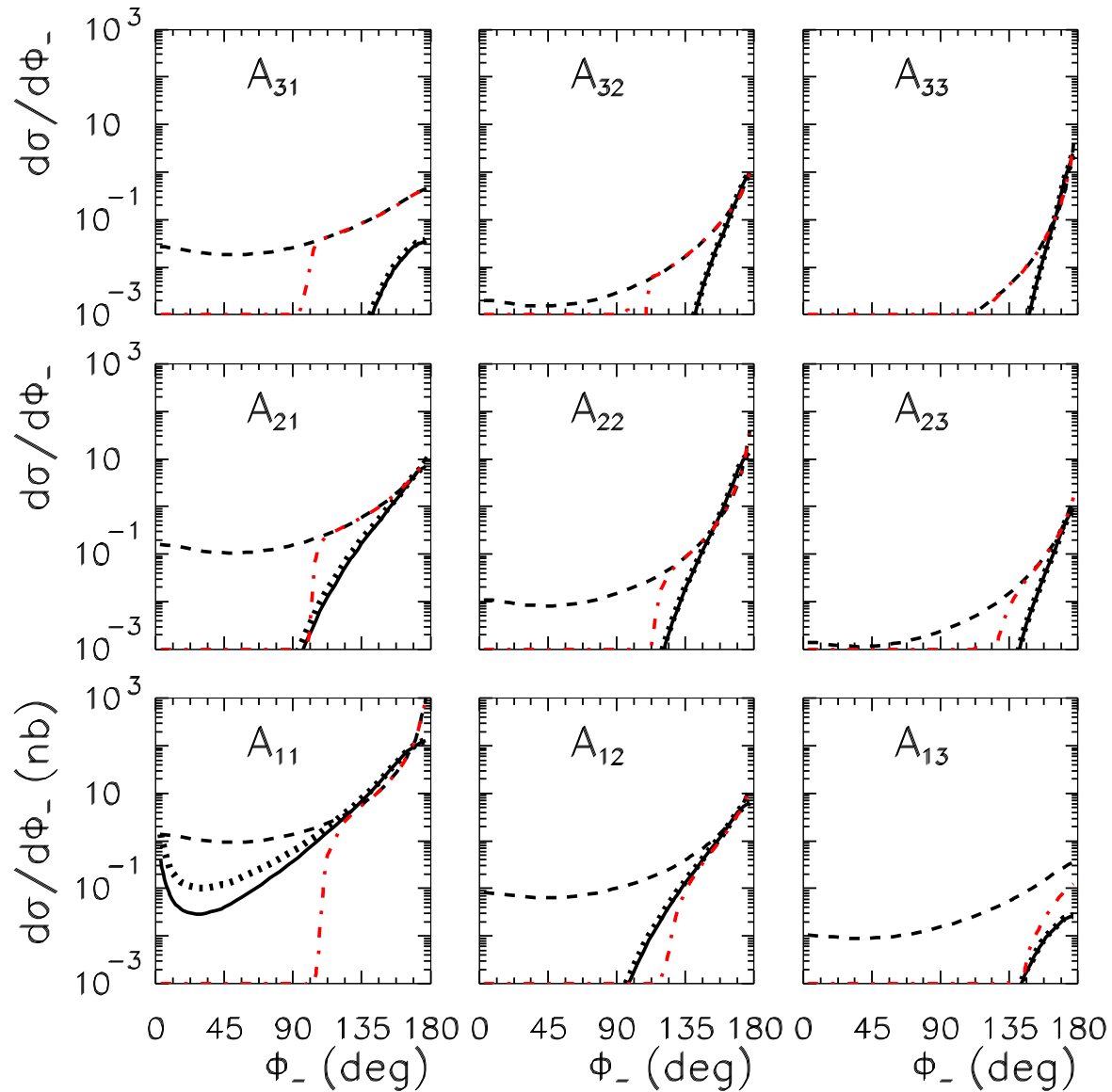



Photon hadron correlations

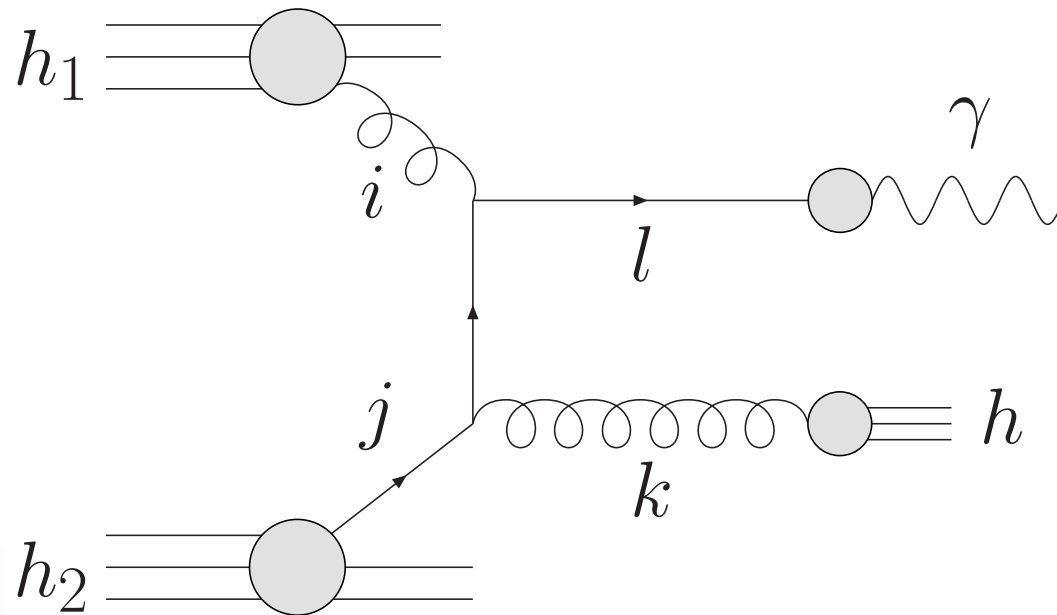
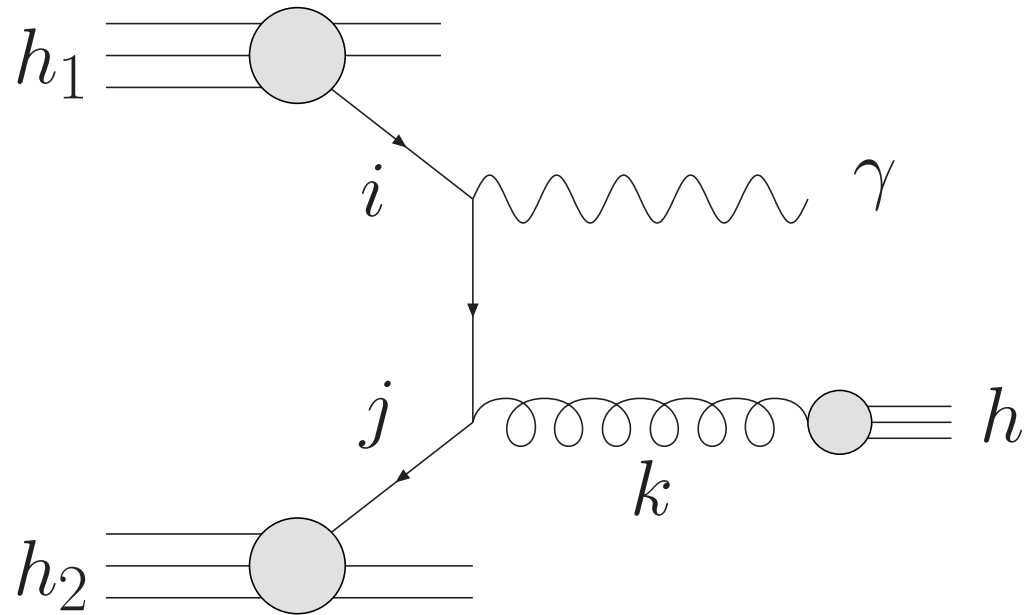



Photon hadron correlations - results

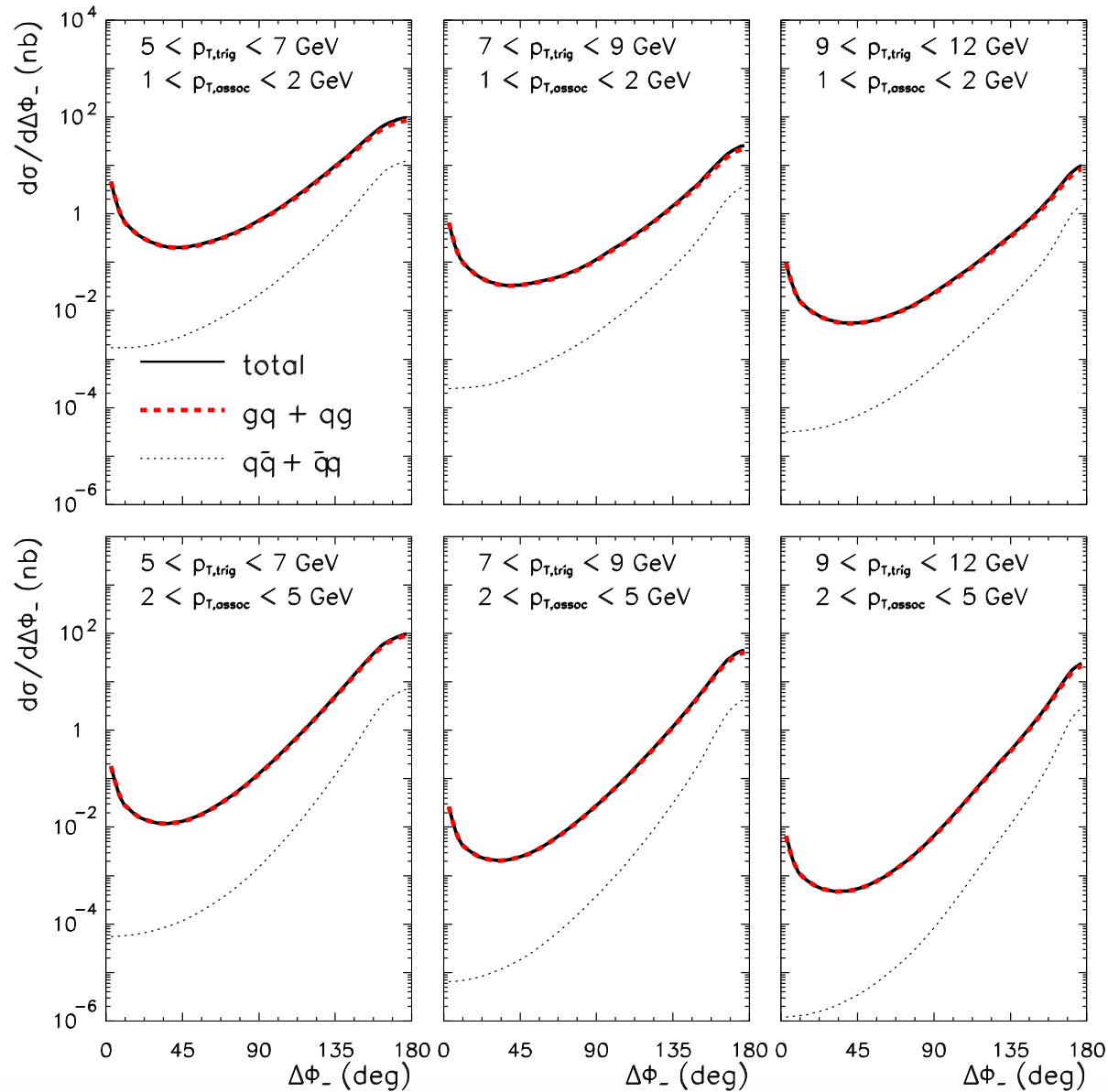



Summary/Conclusions of photon-jet correlation

- Good agreement with exp. data using **Kwiecinski** UPDFs
(carefull treatment of the evolution of the QCD ladder)
- Predictions made for **LHC** based on several UPDFs
- The k_t -factorization approach is also better tool
 - for $\phi_- < \pi/2$ if leading parton/photon condition is imposed
 - for $\phi_- = \pi$ (no singularities)
- RHIC measures γ -hadron, next step inclusion of jet hadronization



Drell-Yan with k_t smearing

Lowest order process:

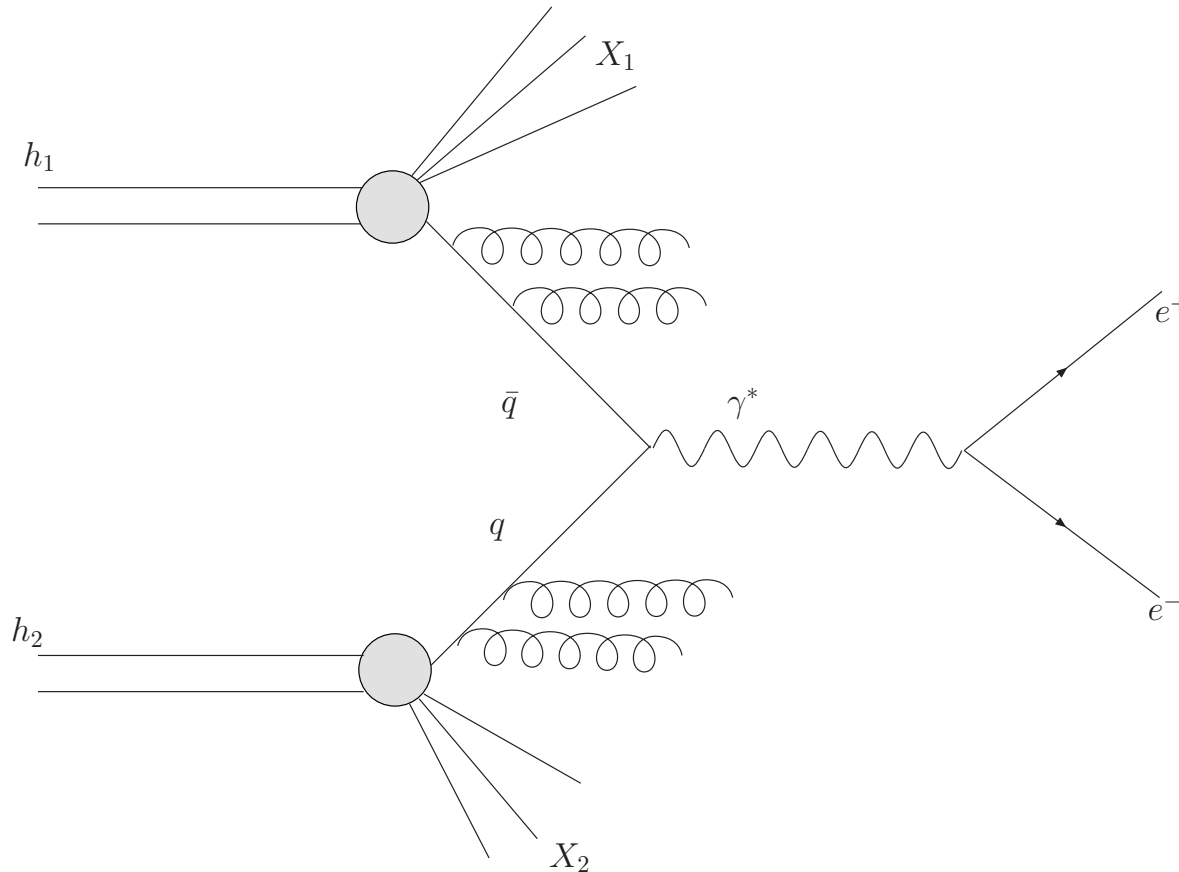

Initial quarks and antiquarks

Kwieciński UPDFs a good tool to include **initial transverse momenta**

Nonzero transverse momenta of the lepton pair.



Drell-Yan with k_t smearing

Examples of higher order subprocesses:

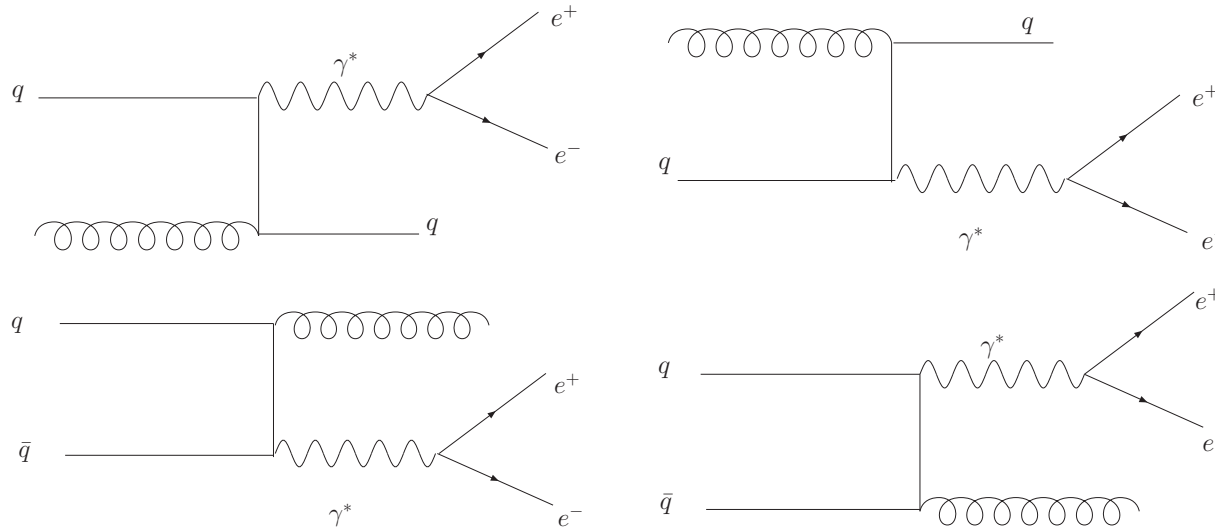

Initial k_t included
No singularities

Drell-Yan versus semileptonic decays

Drell-Yan, $O(\alpha_s^1)$

Semileptonic decays of D and \bar{D}

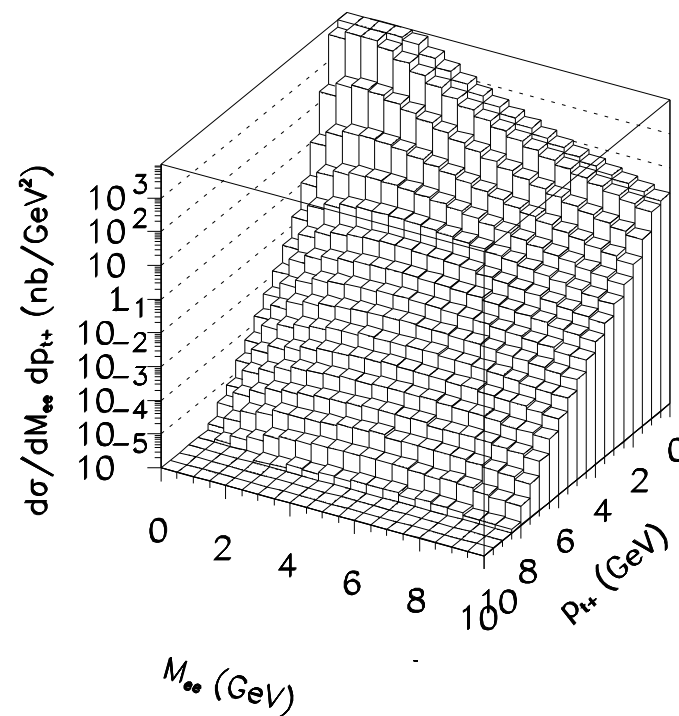
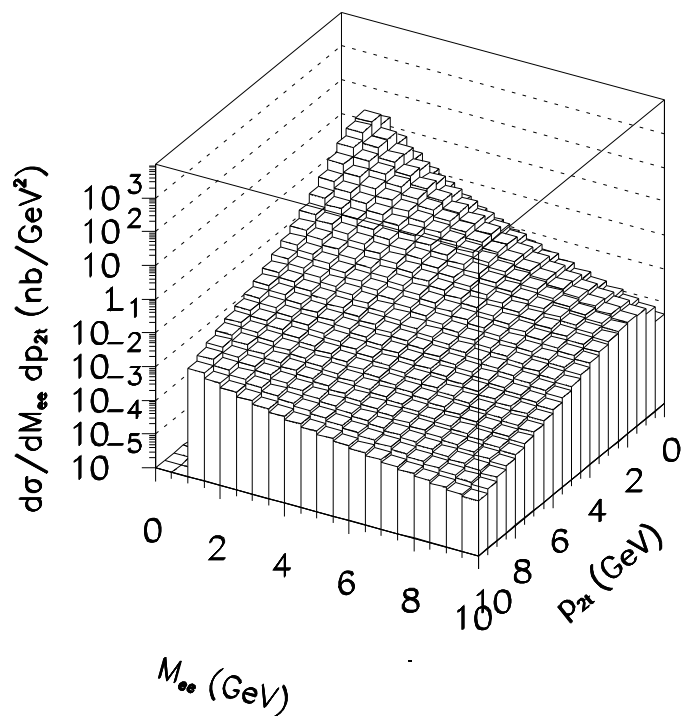

$W=200$ GeV, Kwieciński UPDFs for both



Summary of SLD and DY

- We have calculated (p_{1t}, p_{2t}) and azimuthal e^+e^- **correlations** including:
 - (a) $gg \rightarrow c\bar{c} \rightarrow D\bar{D} \rightarrow e^+e^-$,
 - (b) $gg \rightarrow b\bar{b} \rightarrow B\bar{B} \rightarrow e^+e^-$,
 - (c) $O(\alpha_s^0)$ and $O(\alpha_s^1)$ Drell-Yan within k_t -**factorization approach**.
- For **SLD** decorrelation in azimuthal angle ϕ_{ee} is due to:
 - (a) decay $D \rightarrow e^+$ ($\bar{D} \rightarrow e^-$)
 - (b) **initial k_t -smearing** of gluons (UGDFs)
- For **Drell-Yan** decorrelation in ϕ_{ee} is due to:
 - (a) **initial k_t -smearing** of quarks and antiquarks.
- At RHIC ($W=200$ GeV) **dominance of SLD over DY** in the large part of the phase-space. At LHC it may be even worse !



J/ψ - gluon correlations

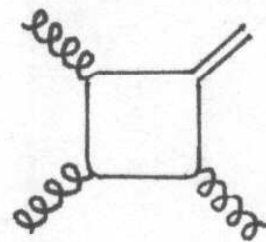

a)

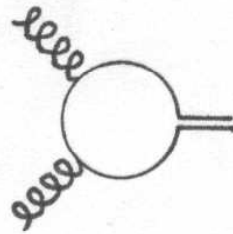

b)

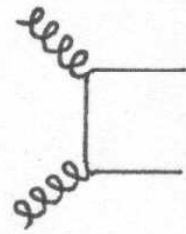

c)

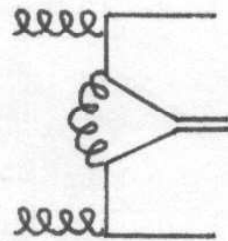
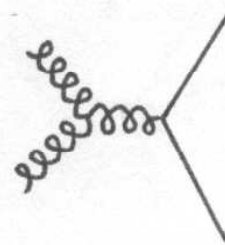

d)

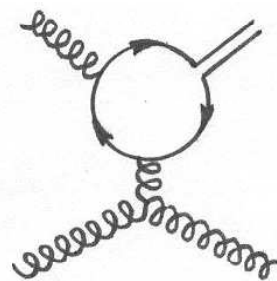
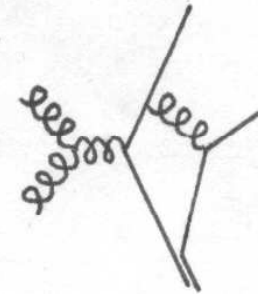
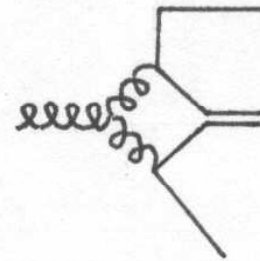
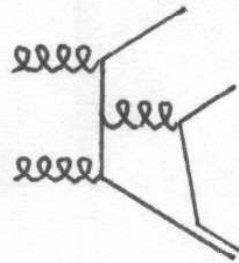

e)

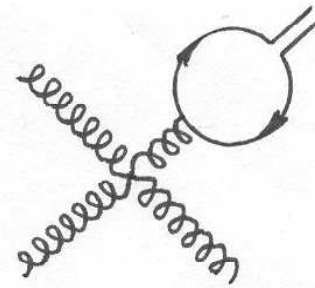
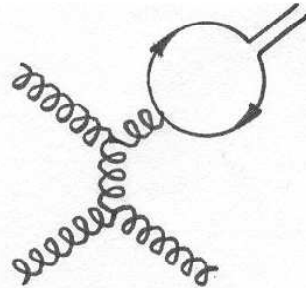



J/ψ - gluon correlations

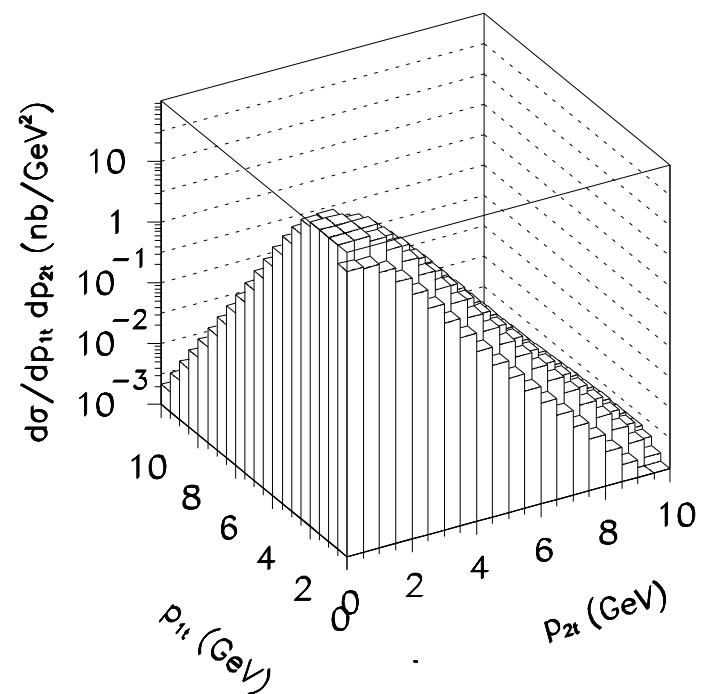
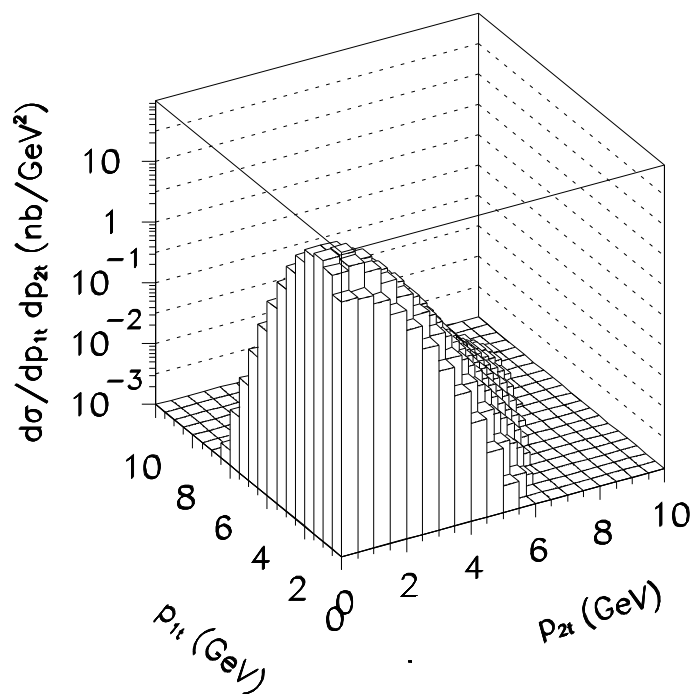

Kwieciński UGDF

$\mu^2 = 10 \text{ GeV}^2$ (left), $\mu^2 = 100 \text{ GeV}^2$ (right)



J/ψ - gluon correlations, gluons from the ladder

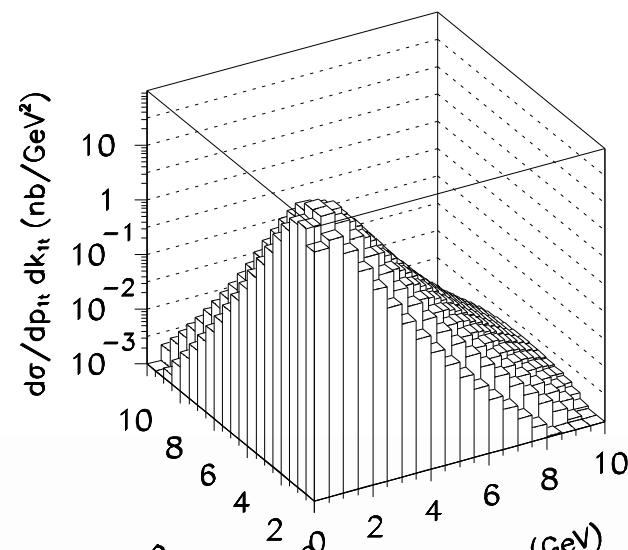
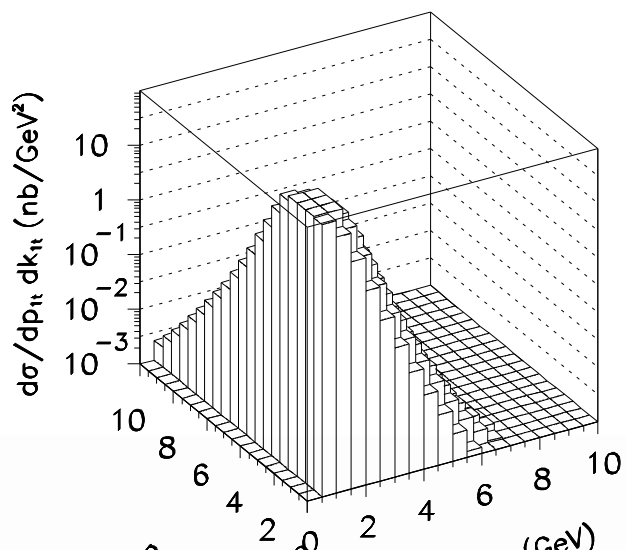
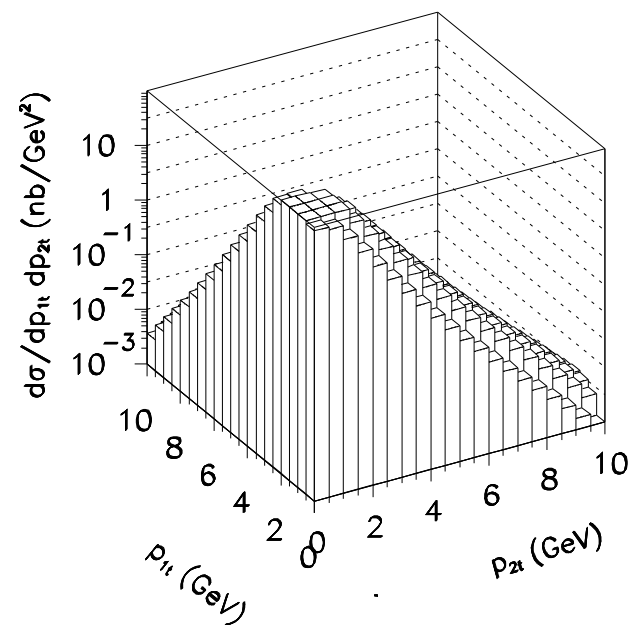
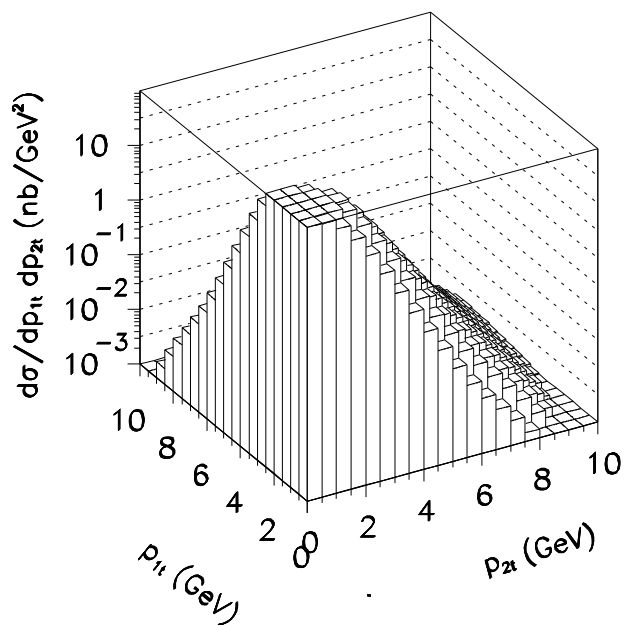



From RHIC to LHC

- Our future: LHC
- Calculations must be done, more difficulties, small x , saturation effects ?
- Large rapidities will be accessible (very small x).
- Small p_t with ALICE (saturation effects).
- Really large p_t will be available (domain of NLO, NNLO).
- Good lack for LHC and the correlation program for proton-proton collisions.
- Nuclear correlation program is very interesting at RHIC, It will be the same at LHC.



For our future with LHC

